

**THE CORPORATION OF THE DISTRICT OF SUMMERLAND**

**SUBDIVISION AND DEVELOPMENT SERVICING  
BYLAW NO. 2022-042**

# CONTENTS

<b>PART 1. TITLE</b> .....	<b>3</b>
<b>PART 2. SEVERABILITY</b> .....	<b>3</b>
<b>PART 3. INTERPRETATION</b> .....	<b>3</b>
<i>Purpose</i> .....	3
<i>References</i> .....	3
<i>Definitions</i> .....	4
<i>Standards of Measure</i> .....	8
<i>Schedules</i> .....	8
<i>Master Municipal Construction Document (MMCD)</i> .....	8
<b>PART 4. SERVICING REQUIREMENTS FOR SUBDIVISIONS AND DEVELOPMENTS</b> .....	<b>9</b>
<i>Servicing Requirements</i> .....	9
<i>Servicing Requirements on An Adjacent Highway</i> .....	10
<i>Servicing Requirements on a Building Site</i> .....	10
<i>Requirements must be Directly Attributable to the Development</i> .....	10
<i>Works and Services in Highway Rights of Way</i> .....	10
<i>Excess or Extended Services</i> .....	10
<i>Cash in Lieu</i> .....	11
<b>PART 5. EXEMPTIONS AND UNIQUE CIRCUMSTANCES</b> .....	<b>11</b>
<i>Exemptions from Services at Subdivision</i> .....	11
<i>Unique Circumstances for Subdivision</i> .....	11
<i>Exemptions from Services at Building Permit</i> .....	12
<i>Unique Circumstances for Building Permit</i> .....	13
<i>Alternative Designs</i> .....	13
<b>PART 6. FEES AND SECURITY</b> .....	<b>13</b>
<i>Fees and Payment of Charges</i> .....	13
<i>Development Approval Fees</i> .....	13
<i>Works and Services Security</i> .....	13
<i>Maintenance Security</i> .....	13
<b>PART 7. GENERAL PROVISIONS</b> .....	<b>14</b>
<i>Project Supervision and Certification</i> .....	14
<i>Consulting Engineer</i> .....	14
<i>Cost of Services</i> .....	14
<i>Latecomer</i> .....	14
<i>Transfer of Ownership</i> .....	15
<i>Stop Work Order</i> .....	15
<i>Record Drawings</i> .....	15
<i>Forms</i> .....	15
<b>PART 8. Enforcement</b> .....	<b>15</b>
<i>Authorization to Enter</i> .....	15
<i>Violation and Offence</i> .....	16
<i>Offences and Penalty</i> .....	16
<b>PART 9. REPEAL AND ADOPTION</b> .....	<b>16</b>

**Schedule A** – Works and Services Requirements

**Schedule B** – Quality Control and Assurance

**Schedule C** – Design Standards

**Schedule D** – Supplementary Construction Specifications

# The Corporation of the District of Summerland

## Subdivision and Development Servicing Bylaw No. 2022-042

*A bylaw to regulate and require the provision of works and services in connection with the subdivision and development of land.*

---

WHEREAS pursuant to the *Local Government Act*, the *Council* of the District of Summerland may, by bylaw, regulate and require the provision of *works and services* for the *subdivision or development* of land;

NOW THEREFORE BE IT RESOLVED that the Municipal *Council* of the District of Summerland, in open meeting assembled, hereby ENACTS AS FOLLOWS:

### PART 1. TITLE

1.1. This bylaw may be cited as “Subdivision and Development Servicing Bylaw No. 2022-042”.

### PART 2. SEVERABILITY

2.1 If a section, subsection, paragraph, subparagraph or phrase in this bylaw is for any reason declared invalid by a court of competent jurisdiction, the decision will not affect the validity of the remaining portions of this bylaw.

### PART 3. INTERPRETATION

#### Purpose

3.1. The purpose of this bylaw is to establish standards for *Works and Services* which must be constructed and installed to service any *Subdivision or Development* of lands within the District of Summerland.

#### References

- 3.2. Every reference to this bylaw in this or another bylaw of the *District* is a reference to this bylaw as amended to the date of the reference.
- 3.3. Every reference to the Master Municipal Construction Document (*MMCD*) is a reference to the most recent version of the *MMCD*.
- 3.4. Definitions of words and phrases used in this bylaw that are not included in the definitions in this part have the meanings commonly assigned to them in the context in which they are used in this bylaw, considering the specialized use of terms with the various trades and professions to which the terminology applies.

## Definitions

3.5. Unless otherwise defined in this Bylaw, a word or expression in this Bylaw has the meaning assigned to it in the *Local Government Act*, *Interpretation Act*, *Community Charter*, *Transportation Act* or *Land Title Act* or any of successor legislation.

3.6. In this bylaw, the following words are defined:

"Application for Building Permit" means the information, documents, agreements, covenants and fees required under this bylaw for a *development*.

"Application for Subdivision" means the information, documents, agreements, covenants and fees required under this bylaw for a *subdivision*.

"Approval, Final" means the *Approving Officer's* affixation of their signature to the *subdivision* plan pursuant to the *Land Title Act*.

"Approving Officer" means the person appointed by the *District* as the Approving Officer under the *Land Title Act*, and includes their lawful designate.

"Benefiting Lands" means lands, other than lands that are the subject of the *Owner's Application for Subdivision* or *Application for Development*, that are capable of being connected to or serviced by *Excess or Extended Services* and are identified as such in a *Latecomer Agreement*.

"Building Bylaw" means the *District* of Summerland Building Bylaw, as amended.

"Building Official" means the person appointed by the *District* as the Building Official under the *Building Bylaw*, and includes their lawful designate.

"Building Permit" means permission or authorization, in writing, by the *Building Official* to perform work regulated by the *Building Bylaw* and the British Columbia Building Code.

"Certificate of Acceptance" means a certificate issued by the *District* verifying that all conditions of this bylaw have been met by the *Owner*.

"Certificate to Proceed with Construction" means a notice issued by the *Approving Officer* authorizing the *Owner* to proceed with *construction* of the *Works and Services*.

"Certificate of Substantial Performance" means a certificate issued by the *Consulting Engineer*, certifying that Substantial Performance of all of the *Works and Services* has been achieved.

"Certificate of Total Performance" means a certificate issued by the *Consulting Engineer*, certifying that Total Performance of all of the *Works and Services* has been achieved.

"Certified Irrigation Designer" means an individual certified by the Irrigation Industry of British Columbia.

"Chief Administrative Officer" means the Chief Administrative Officer of the *District*, or designate.

"Community Sewer System" means a sanitary sewer or a system of sewage disposal works which is owned, operated and maintained by the *District*.

"Community Stormwater Management System" means a system of works owned, operated and maintained by the Ministry of Transportation and Infrastructure or the *District*, designed and constructed to control the collection, conveyance and disposal of surface and other water.

"Community Water System" means a system of waterworks which includes the water distribution and treatment facilities which are owned, operated or maintained by the *District*.

"Construct" or "Construction" means build, erect, install, repair, alter, add, enlarge, move, locate, re-locate, re-construct, upgrade, demolish, remove, excavate, or shore.

"Consulting Engineer" means a *professional engineer*, registered under the Engineers and Geoscientists Act retained by the *owner* to work on their behalf.

"Contract Documents" means the contract documents between the *Owner* and its contractor in connection with the Construction of *Works and Services*.

"Council" means the Municipal Council of the *District* of Summerland.

"Cul-de-sac" means a *highway* with only one point of intersection with another and which terminates in a vehicular turning area.

"Design Drawings" means the drawings identifying the *Works and Services* requirements of this bylaw, provided by the *Owner* and submitted to the *District* pursuant to an *Application for Subdivision*.

"Develop" or "Development" means any construction to which the *Building Bylaw* applies.

"District" means the District of Summerland.

"Director" means the Director of Works and Infrastructure for the *District* or their designate.

"Excess or Extended Services" means those *Works and Services* in respect of:

- (a) a portion of a *Highway* system that will provide access to *Benefiting Lands*; and
- (b) a portion of a water, sewage or drainage system that will serve *Benefiting Lands*.

"Estimated Cost of Works and Services" means an estimate prepared by the *Consulting Engineer* that itemizes the fair market value of the Work and Services and which includes the value of all professional *Fees* for design, approvals, Construction period services and *Record Drawings*.

"*Fees*" means those *fees* payable to the *District* in connection with the Subdivision or *Development* of land, as prescribed by the District's Development Application Procedures Bylaw and Fees and Charges Bylaw.

"Final (Subdivision) Approval" means the execution by the *Approving Officer* of a plan of Subdivision.

"Frontage" means that length of *lot* boundary which immediately adjoins a *highway*, other than a *lane* or walkway.

"Hillside" means areas identified as Hillside on Map A2 set out in Schedule A.

"Highway" includes a street, *road*, *lane*, bridge, viaduct, and any other way open to public use, other than a private right of way on private property.

"Highway Reservation Agreement" means an agreement between the *Owner* and the *District*, in the form prescribed by the *District*, as referred to in the *Local Government Act*.

"Industrial" means areas identified as Industrial on Map A2 set out in Schedule A.

"Lane" means a *highway* more than 3 metres but not greater than 8 metres in width, intended to provide secondary access to *parcels* of land. A lane is not to be considered a partial street.

"Latecomer" means an *Owner* of *Benefiting Lands* who wishes to connect to or use Excess or Extended Services prior to the expiration of a Latecomer Agreement to which the *Benefiting Lands* are subject, provided that a Latecomer who makes an *Application for Subdivision*, or an *Application for Development*, with respect to the *Benefiting Lands*, will also be considered an "Owner" of a *Parcel* or proposed *Parcel* for the purpose of this bylaw.

"Latecomer Agreement" means an agreement between the *Owner* and the *District*, in the form prescribed by the *District*, as referred to in the *Local Government Act*.

"Latecomer Charges" means those charges determined and imposed by the *District* and as defined by the Latecomer Agreement.

"Lot" means any *parcel*, block or other area in which land is held or into which it is subdivided, but does not include a *Highway*.

"Maintenance Bond" means:

- (a) a deposit in the form of cash or a certified cheque provided for the *Maintenance Period*, or
- (b) an unconditional irrevocable standby letter of credit in a form satisfactory to the *District*, expiring no earlier than one year from the date of issuance and providing for a right of renewal unless the bond or letter of credit is perpetual, issued to the *District* by a branch of a chartered bank, credit union or trust company.

"Maintenance Period" means:

- (c) the period of one year from the date on which all obligations of the *Owner* and its *Consulting Engineer(s)* have been performed.
- (d) with respect to *Works and Services* that appear to be incomplete, defective or deficient during the Maintenance Period referred to in either (a) above, the period of one year from the date on which such *Works and Services* are completed or corrected.

"MMCD" means the most recent version of the MMCD of the Master Municipal Construction Documents.

"Medical Health Officer" means the official appointed under the Health Act who has jurisdiction over the area in which the *subdivision* is located.

"OCP" means the *District* of Summerland Official Community Plan.

"Off-site Works and Services" means *Works and Services* that are directly attributable to the *Subdivision* or *Development* and that will be owned and maintained by the *District* following issuance of the *Certificate of Total Performance*.

"Owner" means the registered owner of an estate in fee simple of land, or an agent duly authorized by the owner in writing in the prescribed form, and also where the context or

- (a) ~~circumstances so require~~ a registered life estate;
- (b) a registered holder of an agreement for sale;
- (c) a holder or occupier of land held in the manner mentioned in Sections 228 and 229 of the *Community Charter* (Crown land held by others); or
- (d) a lessee with authority to build on land.

"Owner/Consulting Engineering Confirmation" means a confirmation letter from the *Owner* and the *Consulting Engineering Firm*, in the form prescribed by the *District*.

"Panhandle Lot" means any *lot* which gains *highway frontage* through the use of a narrow strip of land which is an integral part of the said *lot* (hereinafter called the "access strip").

"Parcel" means any *lot*, block or other area in which land is held or into which it is subdivided, but does not include a *highway*.

"Preliminary Layout Approval " means such drawings, plans, information and documents as the *Approving Officer* requires, and in such form as is required by the *District*, to determine, on a preliminary basis:

- (a) whether the proposed *Subdivision* would be against the public interest or otherwise unsuitable for *Subdivision*; and
- (b) if not against the public interest or otherwise unsuitable for *Subdivision*, what the *Owner* must include in the *Application for Subdivision Approval*.

"Preliminary Layout Approval Letter" means a letter from the *Approving Officer* to the *Owner* advising of the *Approving Officer's* response to Preliminary Layout Approval information provided by the *Owner*.

"Professional Engineer" means a person who is registered or duly licensed as such under the provisions of the Engineers and Geoscientists Act of British Columbia.

"Public Access Route" means Public Land located between or beside *lots* that will provide a connection between public *roads* or between public *roads* and open space or parks behind the *lots* fronting the public *road*.

"Public Land" means land owned by the *Owner*, Crown or *District* and land that, after *subdivision approval* or title transfer, will be owned by the Crown or the *District*. Public Land may include, but is not limited to: boulevards, medians, traffic circles, stormwater management facilities, *public access routes*, natural open spaces and parks.

"Record Drawings" means drawings prepared by and certified by the *Consulting Engineer* that record the location, properties and details of all *Works and Services*.

"Road" means the portion of a *highway* to be used for vehicular traffic movement.

"Rural" means areas identified as Rural on Map A2 set out in Schedule A.

"Rural (Well)" means areas identified as Rural (Well) on Map A2 set out in Schedule A.

"Service Application" means an application made by the *Owner* to connect to the *District's Works and Services*, in the form prescribed by the *District*.

"Servicing Agreement" means an agreement between the *Owner* and the *District* made pursuant to Section 219 of the *Land Title Act*, in the form prescribed by the *District* of Summerland, as referred to in the *Local Government Act*. The *Servicing Agreement* describes the terms and conditions agreed upon between the *District* and the *Owner* relative to provision of *Works and Services* associated with a *Subdivision or Development*.

"Statutory Declaration" means the *Owner's* sworn declaration that all amounts relating to the *Works and Services* due and owing to third parties as of the date on which the Statutory Declaration is given have been paid, including all amounts owing to contractors and sub-contractors, and all assessments and levies under applicable legislation.

"Statutory Right-of-Way Agreement" means an agreement between the *Owner* and the *District*, in the form prescribed by the *District*, as referred to in the *Land Title Act*.

"Subdivide" or "Subdivision" means:

- (a) the division of land into two or more *Parcels* whether by plan, apt descriptive words, or otherwise;
- (b) the consolidation of *Parcels* into one *Parcel* by plan; or
- (c) the creation of a *Highway* or a portion of a *Highway* by plan.
- (d) a boundary adjustment between two *parcels*.

"Substantial Performance" means the stage of performance of all of the *Works and Services* when the *Works and Services* are ready to be used for their intended purpose, as determined by the *Director*.

"Surveyor" means a person currently licensed to practice by, and is in good standing with, the Association of British Columbia Land Surveyors.

"Total Performance" means when all *Works and Services*, including all incomplete, defective or deficient *Works and Services* that were apparent when the *Certificate of Substantial Performance* was issued have been completed or corrected, as certified by the *Consulting Engineer* and verified by the *District*.

"Urban Local" means areas identified as Urban Local on Map A2 set out in Schedule A.

"Watercourse" means any natural or artificial stream, river, creek, ditch channel, canal, conduit, culvert, drain, waterway, gully or ravine in which water flows in a definite direction or course, either continuously or intermittently, and has a definite channel, bed and banks and includes an area adjacent thereto subject to inundation by reason of overflow or flood water.

"Works and Services": includes site grading, *Highways*, sidewalks, boulevards, boulevard crossings, transit bays, street lighting, wiring, water distribution systems, fire hydrants, sewage collection and disposal systems, drainage collection and disposal systems, engineering, *record drawings* and such other infrastructure or systems as may be provided within the *District* from time to time.

"Zone" means a zone identified and defined in *District of Summerland Zoning Bylaw*.

## **Standards of Measure**

- 3.7. Any equivalent imperial units of measure shown, in parenthesis, after metric units in any schedule to this bylaw are for information purposes only and do not form part of this bylaw.

## **Schedules**

- 3.8. The following schedules are attached to and form part of this bylaw:

- Schedule A – *Works and Services* Requirements
- Schedule B – Quality Control and Assurance
- Schedule C – Design Standards
- Schedule D – Supplementary Construction Specifications

## **Master Municipal Construction Document (MMCD)**

- 3.9. All *Works and Services* shall be completed in accordance with the most recent edition of *MMCD*, the Master Municipal Construction Document, which shall form part of this bylaw, unless specifically



modified in Schedule D.

- 3.10. If the requirements in Schedule C – Design Standards conflict with the requirements set out in the *MMCD*, the specifications and drawings found in Schedule C – Design Standards shall take precedence over specifications and drawings found in the *MMCD*.

## **PART 4. SERVICING REQUIREMENTS FOR SUBDIVISIONS AND DEVELOPMENTS**

### **Servicing Requirements**

- 4.1. No *Owner* shall *subdivide* land in the *District* unless:
- (a) the *Works and Services* required by this bylaw have been provided by the *Owner* to the satisfaction of the *Approving Officer*, or
  - (b) the *Owner* has entered into a *Servicing Agreement* with the *District* to construct and install the required *Works and Services* by a date specified in the agreement, and provided to the *District* security as required in Part 6.
- 4.2. No *Owner* shall construct a building or structure in the *District* for which a *building permit* is required unless:
- (a) the *Works and Services* required by this bylaw have been provided by the *Owner* to the satisfaction of the *Approving Officer*, or
  - (b) the *Owner* has entered into a *Servicing Agreement* with the *District* to construct and install the required *Works and Services* by a date specified in the agreement, and provided to the *District* security as required in Part 6.
- 4.3. *Roads*, sidewalks, bicycle lanes, boulevards, roadway lighting, wiring, traffic signals, retaining wall systems and alterations, landscaping and any other components associated with the provision of transportation systems shall be provided in accordance with the level of service set out in Schedule A and the standards set out in Schedules B to D established under this bylaw.
- 4.4. Water systems shall be provided in accordance with the level of service set out in Schedule A and the standards set out in Schedules B to D established under this bylaw. Water systems shall be connected to an existing *Community Water System*, unless located in an area that permits connection to individual wells as set out in Schedule A.
- 4.5. Despite section 4.4, even if located in an area that permits connection to individual wells, the *parcel* or *development* shall be connected to an existing *Community Water System* if the *Community Water System* extends along the *frontage* of the *parcel*, or if the *Community Water System* exists within 100 metres of the *parcel*.
- 4.6. Sewer systems shall be provided in accordance with the level of service set out in Schedule A and the standards set out in Schedules B to D established under this bylaw. Sewer systems shall be connected to an existing *Community Sewer System*, unless located in a *Rural* area that permits on site sanitary sewage effluent by ground disposal set out in Schedule A and the standards set out in Schedules B to D established under this bylaw.
- 4.7. Despite section 4.6, even if located in an area that permits on site sanitary sewage effluent by ground disposal, the *parcel* or *development* shall be connected to an existing *Community Sanitary System* if the *Community Sanitary System* extends along the *frontage* of the *parcel*, or if the *Community Sanitary System* exists within 100 metres of the *parcel*.
- 4.8. Stormwater Management systems shall be provided in accordance with the level of service set out in Schedule A and the standards set out in Schedules B to D established under this bylaw.

Stormwater management systems shall be connected to an existing *Community Stormwater Management System*, unless located in an area that permits other forms of Stormwater Management set out in Schedule A.

- 4.9. The *Works and Services* required in Part 5 shall be provided on that portion of any *highway* or *lane* immediately adjacent to the *parcel* that is the subject of the *subdivision* or *building permit* application, as the case may be.

#### **Servicing Requirements on An Adjacent Highway**

- 4.10. *Council* hereby delegates to the *Director* the power under Section 506(8) of the *Local Government Act* to require that, prior to *Subdivision approval* or issuance of a *Building Permit* the *Owner* shall provide *Works and Services* directly attributable the *subdivision* or *development*, in accordance with the level of service set out in Schedule A and the standards set out in Schedules B to D of this bylaw, on that portion of every *Highway* immediately adjacent to the *Parcel* being subdivided or Developed up to the centre line of the *Highway*.

#### **Servicing Requirements on a Building Site**

- 4.11. *Council* hereby delegates to the *Director* the power under Section 506(9) of the *Local Government Act* to require that the *Owner* shall, as a condition of the issuance by the City of a *Building Permit*, provide *Works and Services* directly attributable the *subdivision* or *development*, on the site subject to the *Building Permit* in accordance with the level of service set out in Schedule A and the standards set out in Schedules B to D of this bylaw.

#### **Requirements must be Directly Attributable to the Development**

##### *Explanatory Note:*

*For clarity, the Director shall exercise the powers delegated under Sections 4.9 and 4.10 in accordance with Section 506 (10) of the Local Government Act, which states that the requirements:*

- *may be made only to the extent that they are directly attributable to the subdivision or development, and*
- *must not include specific services that are included in the calculations used to determine the amount of a development cost charge, unless the owner agrees to provide the services.*

#### **Works and Services in Highway Rights of Way**

- 4.12. The *Works and Services* required by this bylaw shall be provided in dedicated *highways*, unless the *Director* has approved the location of the *Works and Services* in a statutory right of way granted to the *District*, in which case the statutory right of way, including any required plan of right of way, must be prepared at the cost of the Developer, in terms satisfactory to the *Director*, and deposited concurrently with the deposit of the *subdivision* plan in the case of a *subdivision* application and prior to the issuance of an occupancy permit in the case of a *building permit* application.
- 4.13. Any *Works and Services* required by this bylaw within an existing *highway* right-of-way shall be provided, at a minimum, to the centre line of the *highway* along the entire *frontage* of the property, except that all required utility upgrades for water, sanitary sewer, stormwater, natural gas, electrical, street lighting or telecommunications shall be provided within the entire right-of-way regardless of its location.

#### **Excess or Extended Services**

4.14. Council delegates to the *Approving Officer* the authority to:

- (a) Determine what *Excess or Extended Services* are required in connection with a *Subdivision or Development*;
- (b) Determine whether the cost of those *Excess or Extended Services* are excessive such that the municipality cannot pay for those costs;
- (c) Identify the benefiting properties in relation to *Excess or Extended Services*; and
- (d) Determine what proportion of the costs associated with the *Excess or Extended Services* is associated with each benefiting property.

### **Cash in Lieu**

4.15. The *Approving Officer* may require the *Owner* to provide to the *District*, cash in lieu of the required *Works and Services*. The amount of cash in lieu shall be approved by the *Approving Officer* but shall not exceed 100% of the value of the design, *construction*, and installation of the required *Works and Services*. The *Consulting Engineer* may be required to prepare and submit the *Estimated Cost of Works and Services* to assist the *Approving Officer* in their evaluation.

## **PART 5. EXEMPTIONS AND UNIQUE CIRCUMSTANCES**

### **Exemptions from Services at Subdivision**

- 5.1. Despite the requirements in Part 4, the *Works and Services* requirements of this bylaw do not apply to a *Subdivision* which creates only:
- (a) a *Highway* dedication;
  - (b) park land;
  - (c) a *Parcel* for the installation of public utilities and related structures and equipment; or
  - (d) a consolidation of *lots*; or
  - (e) a *lot* line adjustment, in which the number of buildable *lots* is not increased, except that the *owner* must meet section 5.3.
- 5.2. Council hereby delegates to the *Approving Officer* the power to exempt a *parcel* from the statutory or bylaw minimum *frontage* provided for in Section 512 of the *Local Government Act*.

### **Unique Circumstances for Subdivision**

- 5.3. Despite section 5.1, where an *owner* is making an application to adjust *lot* lines, and the *lot* line adjustment does not create any additional *parcels*, the *owner* shall:
- (a) extend the existing services to the adjusted *parcel lot* line;
  - (b) provide a drawing, prepared by a *surveyor*, indicating the locations of all existing and extended services, including power, water, sewer, and onsite disposal, if applicable; and
  - (c) identify which *parcel* will connect to which service.

If a service is not located in a dedicated *road* right of way or within the *parcel* that it will service, the location and access to that service shall be protected by an easement.

- 5.4. Despite the requirements in Part 4, an *owner* of land zoned RSD1, RSD1(i), RSD2, RSD3, RMH, or RDH, will not be required to *construct* or install one or more of the following servicing Bylaw requirements: drainage, street lighting, underground wiring, fire hydrants, water, curb, gutter, or sidewalk on the abutting *highway* if:
- (a) the **subdivision** is not within 75 meters of an area as determined using the method shown on Figure 5.1 where an equivalent level of works is constructed or installed or is required to be constructed and installed; and
  - (b) the total *highway frontage* abutting the *subdivision* or *development* is less than 70 meters; and
  - (c) the *subdivision* creates not more than one new *parcel* and the new *parcel* and the remainder have no further *subdivision* potential under the current zoning; and
  - (d) new streets or street extensions are not required to service the *development*; **and**
  - (e) the *Director* agrees that the existing standard of *works and services* are adequate to service the *subdivision*.

Exemption for each servicing requirement will be determined independently of the others based on the above criteria. An exemption from one servicing requirement in no way implies an exemption from any or all of the other servicing requirements.

Figure 5.1 Illustration of 75m Measurements

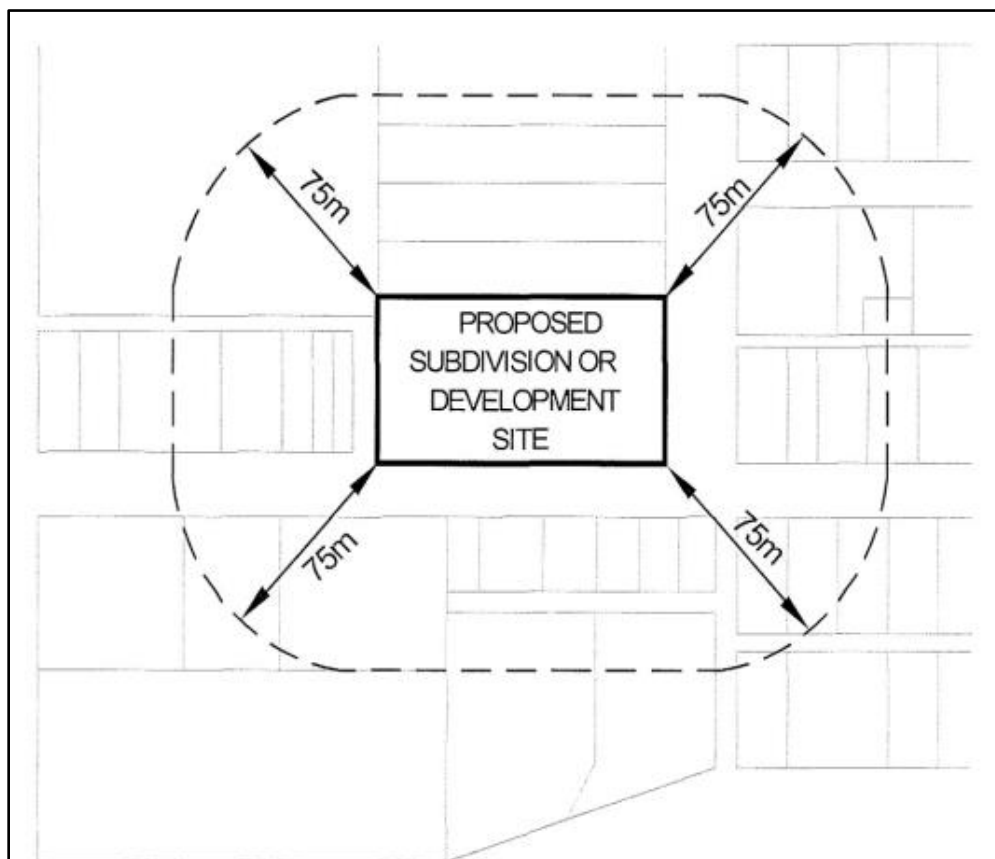

### Exemptions from Services at Building Permit

- 5.5. *Works and Services* requirements of this bylaw do not apply to a *building permit* for internal alterations of a building and/or structure where the principal use of the building and/or structure, or part thereof, is not changing.

## Unique Circumstances for Building Permit

- 5.6. Despite the requirements in Part 4, if a *building permit* is being issued for *construction* of a building on land zoned RSD1, RSD1(i), RSD2, RSD3, A1, A2, CR1, RDH, or RMH, the *Owner* shall:
- (a) comply with the provisions of Schedule D subsection 1.10 - Removal and Disposal of Accumulated Soils; and
  - (b) comply with the provisions of the Sanitary Sewer Regulation Bylaw of the *District* of Summerland as amended from time to time; and
  - (c) No other provisions of the *Subdivision and Development Servicing* Bylaw shall apply.

## Alternative Designs

- 5.7. Despite the requirements in Part 4, the *Director* may approve alternative designs that meet the performance objectives of the requirements set out in Schedules A to D if the *Owner* provides a report prepared by their *Consulting Engineer* clearly demonstrating that the alternative design will meet or exceed the performance objectives of the requirements set out in Schedules A to D.

## PART 6. FEES AND SECURITY

### Fees and Payment of Charges

- 6.1. *Final approval* of the *Subdivision*, issuance of the *Certificate to Proceed with Construction*, issuance of a *Preliminary Layout Approval Letter*, or issuance of *Building Permit*, as the case may be, will not be issued by the *District* until all applicable *fees* and charges have been paid.

### Development Approval Fees

- 6.2. The *Owner* shall pay all engineering and legal *fees* as well as outside consulting costs incurred by the *District* relating to the *subdivision* and servicing of the land, including detailed review and approval of the *Design Drawings*, monitoring the installation of the *Works and Services*, and the costs of connecting the *Works and Services* to the *District's* existing infrastructure.
- 6.3. Prior to issuance of the *Certificate to Proceed with Construction*, the *Owner* shall pay to the *District* an amount equal to 1.5% of the estimated cost to *construct* the *Works and Services* as approved by the *District*.

### Works and Services Security

- 6.4. Final approval of the *Subdivision* or issuance of a *Building Permit* shall not be granted prior to the provision of *Works and Services* unless the *Owner* pays to the *District* a security in an amount equal to 125% of the *Consulting Engineer's* Estimate of the Cost of the *Works and Services* required for the proposed *Subdivision* or *Development* to meet the requirements of this bylaw.
- 6.5. The *Owner* shall be responsible for the actual cost of the *Works and Services* regardless of the adequacy of the security deposited with the *District*.

### Maintenance Security

- 6.6. The *District* shall:
- (a) Return the security required pursuant to Section 6.4 of this bylaw, less ten percent (10%), plus two hundred percent (200%) of the cost to repair deficiencies and defects as estimated by the *Owner's Consulting Engineer* and as approved by the *Director* to cover deficiencies during the one-year *Maintenance Period*;
  - (b) Establish the date of commencement of the one-year *Maintenance Period*, and

(c) Advise the *Owner* of the terms of the one-year *Maintenance Period*.

6.7. All *Works and Services* required to be constructed or provided pursuant to the provisions of this bylaw shall remain the sole responsibility of the *Owner* until a *Certificate of Acceptance* has been issued by the *District*. The *Owner* shall maintain the works and repair or replace any defective works during the one-year *Maintenance Period*. Should the *Owner* fail to maintain, repair or replace said works, the *District* may undertake such maintenance, repairs or replacement using the security provided.

6.8. The *Maintenance Period* shall not commence until:

(a) *Substantial Performance* of the *Works and Services* has been achieved, and;

(b) The *Record Drawings* have been submitted by the *Owner* and approved by the *Approving Officer*.

6.9. Should the *Maintenance Period* commence between the period November 1 and March 31, the *Director* may require the *Maintenance Period* be extended so that it terminates on April 1 following the one-year anniversary of the commencement date of the *Maintenance Period*.

## **PART 7. GENERAL PROVISIONS**

### **Project Supervision and Certification**

7.2 All *Consulting Engineers* that are required as a condition of this Bylaw shall follow the requirements of Schedule B and be on-site during the period of *construction* of all works falling within their particular field of expertise. The *Consulting Engineer* responsible for the respective works shall, upon satisfactory performance of said works, provide the *District* with their written certification that they were, in fact, on-site during the period of *construction* of the works and that said works were installed meeting the requirements of this bylaw.

### **Consulting Engineer**

7.3 The *Owner*, at its expense, shall retain a *Consulting Engineer* to design, inspect, test and certify all *Works and Services*, as set out in Schedule B.

### **Cost of Services**

7.4 All *Works and Services* required by this bylaw shall be constructed at the expense of the *Owner*.

### **Latecomer**

7.5 Where the *Owner* is required by the *District* to provide *excess or extended services*, the *Owner* is entitled to receive *latecomer charges* in accordance with:

(a) The *Local Government Act*; and

(b) The *latecomer* policy of the *District*, where applicable; and

(c) The *latecomer* agreement in a form acceptable by the *Approving Officer*.

7.6 The *Approving Officer* shall require the *Owner* to provide appropriate documentation and associated costs respecting potential *latecomer* eligible properties. The issuance of a *Certificate to Proceed with Construction* shall be withheld until receipt of the said information.

- 7.7 The interest rate applicable to *latecomer charges* as per the *Local Government Act* shall be calculated by the *District* at the time the *latecomer* agreement is signed, and shall equal the prime lending rate of the chartered bank used by the *District*, less one percent.

### **Transfer of Ownership**

- 7.8 *Works and Services* constructed and installed under this bylaw become the property of the *District* or the agency having jurisdiction, subject to no encumbrances, on issuance of the *Certificate of Acceptance*.

### **Stop Work Order**

- 7.9 The *Approving Officer*, *Director*, or the Bylaw Enforcement Officer may order:
- (a) a person who contravenes this bylaw to comply with the bylaw within a time limit specified in the order;
  - (b) a person to stop *construction* on the work, or any part thereof, if such work is proceeding in contravention of this bylaw.

### **Record Drawings**

- 7.10 The *Owner* must submit *Record Drawings* following the completion of the *Works and Services* and prior to issuance of a *Certificate of Total Performance*.
- 7.11 If the *Owner* wishes to receive *Subdivision Approval* prior to submission of required *Record Drawings*, tests results, service cards, inspection reports, video reports, maintenance and operations manuals, and professional certifications, such Approval may be granted at the sole discretion of the *Director* of Works and Infrastructure, subject to a deficiency holdback in an amount set by the *Approving Officer* pursuant to this bylaw.

### **Forms**

- 7.12 The *Director* is hereby delegated the powers to execute and amend all forms related to this Bylaw, including:
- (a) Statutory Right of Way;
  - (b) *Servicing Agreements*;
  - (c) Maintenance Agreements;
  - (d) Section 219 Covenants;
  - (e) Drawing Standards Schedule; and
  - (f) *Latecomer Agreements*.

## **PART 8. ENFORCEMENT**

### **Authorization to Enter**

- 8.1 The *Approving Officer*, *Director* or their designates are authorized to enter, at all reasonable times, upon any property or premises to inspect the same in connection with their duties under this Bylaw and to ascertain whether the provisions of this Bylaw are being complied with.

## Violation and Offence

- 8.2 It is an offence for any person to cause, suffer, or permit the *subdivision* of land in contravention of this bylaw or otherwise to contravene or fail to comply with this bylaw.
- 8.3 It is an offence for any person to prevent or obstruct or attempt to prevent or obstruct the authorized entry of the *Approving Officer, Director* or their designates, authorized under this bylaw.

## Offences and Penalty

- 8.4 Any person who violates any of the provisions of this Bylaw, or who suffers or permits any act or thing to be done in contravention or in violation of any of the provisions of this Bylaw, or who neglects to do or refrains from doing anything required to be done by this Bylaw, is liable upon summary conviction to a maximum fine of \$50,000. A separate offence shall be deemed to be committed on each day during, or on which, a violation occurs or continues.

## PART 9. REPEAL AND ADOPTION

- 9.1. "District of Summerland Subdivision and Development Servicing Bylaw No. 99-004, 1999" and all amendments thereto are hereby repealed upon adoption of this bylaw.

Read a first, second, and third time this 12<sup>th</sup> day of December, 2022

Adopted by the Municipal Council of the Corporation of the District of Summerland this 16<sup>th</sup> day of December, 2022.

---

Mayor

---

Corporate Officer



**Schedule A**

**WORKS AND SERVICES REQUIREMENTS**

---

**1.0 ESTABLISHMENT OF SERVICE LEVELS**

The minimum level of service to be constructed by an *Owner* prior to approval of *Subdivision* or *Development* is set out in Table A1 and the locations are identified on Maps A2, A4, A5 and A6. While Table A1 sets out the minimum level of service required, the *Approving Officer* retains the right to require a higher level of service or standard due to the conditions affecting a specific *Subdivision*.

For the purposes of the Level of Service Table A1 below:

**Table A1 - KEY SHEET**

<b><u>ABBREVIATION</u></b>	<b><u>REQUIREMENT</u></b>
WTR	Community water system. In subdivisions which are to be provided with a community water system, each Parcel within the proposed subdivision, or a Parcel being Developed, must be supplied by a water distribution system, including service connections, and with adequate fire flow and protection, which is designed in accordance with the standards prescribed in Schedule C of this Bylaw.
WELL	Where a community water system is not available a proven water supply located on each parcel is permitted.
SWR	Community sanitary sewer system as per Schedule C of this Bylaw.
SWRSEP	Sanitary sewage effluent by ground disposal approved by the Medical Health Officer, or a community sanitary sewer as per Schedule C of this Bylaw.
DITCH	Drainage collection and disposal system by open ditches and culverts.
STM	Closed drainage collection and disposal system as per Schedule C of this Bylaw (i.e. a system other than open ditches).
SL	Street lighting throughout the subdivision as per Schedule C of this Bylaw.
SLI	Street lighting at street intersections only as per Schedule C of this Bylaw.
OH	Overhead electrical and communication wiring as per Schedule C of this Bylaw.
UG	Underground electrical and communication wiring as per Schedule C of this Bylaw.
PHW	Precast concrete headwall for driveway culverts

District of Summerland  
WORKS AND SERVICES REQUIREMENTS

Table A1: Level of Service

Service Area	Utilities					Roadways / Pedestrian Network
	Water	Sanitary*	Storm	Lighting	Wiring	
Urban Local	WTR	SWR	STM	SL	UG	As per Roadway Cross Sections (Schedule C), Maps A2, A4, A5
Downtown Summerland	WTR	SWR	STM	SL	UG	
Industrial	WTR	SWR	STM	SL	OH	
Hillside	WTR	SWR	STM	SLI	UG	
Rural	WTR	SWRSEP	DITCH/PHW	SLI	OH	
Rural (Well)	WELL	SWRSEP	DITCH/PHW	SLI	OH	
Prairie Valley Road – Victoria Road to Cartwright Avenue	WTR	SWR	STM	SL	UG	
Lakeshore Drive - Solly Road to Shaughnessy Avenue	WTR	SWR	STM	SL	UG	

<b>1. Quality Control and Assurance .....</b>	<b>1</b>
1.1 Engineering Requirements.....	1
1.2 <i>Construction</i> Requirements.....	2
1.3 Quality Control and Assurance Plans.....	2

**1. Quality Control and Assurance**

This Schedule sets out the *District's* minimum standards for quality in design, quality in *Construction* and quality in record-keeping for the *Works and Services* to be designed and constructed in accordance with this bylaw.

Minimum design standards are set out in **Schedule C**.

**1.1 Engineering Requirements**

- (a) The *Owner* shall demonstrate to the satisfaction of the *Approving Officer* that the *Owner* has retained or shall retain the services of a *Consulting Engineer* to undertake the design, inspection, testing and record-keeping for the *Works and Services*.
- (b) Upon request of the *Approving Officer*, the *Owner* shall complete and provide the *Approving Officer* with the following information in the *Owner/Consulting Engineering* confirmation letter to demonstrate that the *Consulting Engineer* is qualified to undertake the *Works and Services* and more particularly, has successfully undertaken projects similar in scope, nature and value to the *Works and Services*:
  - The name and address of the *Consulting Engineer* and a summary of the projects that the *Consulting Engineer* has undertaken that are similar in scope, nature and value to the *Works and Services*.
  - The names of the individuals assigned to various aspects of the project by the *Consulting Engineer* together with a summary of the projects that the individual engineers have undertaken that are similar in scope, nature and value to the *Works and Services*.
  - The names and the curriculum vitae for the person(s) that the *Consulting Engineer* proposes/has retained to undertake the inspections and testing on its behalf during the *Construction* of the *Works and Services* together with a summary of the projects that the person(s) has Completed that are similar in scope, nature and value to the *Works and Services*.
  - The *Owner* shall provide the names and addresses of all sub-consultants that the *Consulting Engineer* has/proposes to retain and a summary of the projects that the sub-consultants have completed that are similar in scope, nature and value to the *Works and Services*.

- The *Owner* shall ensure the *Consulting Engineer* designs all *Works and Services* in accordance with this bylaw.
- The *Owner* shall also confirm that the *Consulting Engineer* shall be responsible for the provision of the Design, *Construction* and Record-keeping Quality Control and Assurance Plans described herein.

## **1.2 Construction Requirements**

- (a) The *Owner* shall demonstrate that to the satisfaction of the *Approving Officer* that the *Owner* has or shall retain the services of one or more qualified Contractors to undertake the *Construction* of the *Works and Services*. Upon request of the *Approving Officer*, the *Owner* shall provide the *District* with the name and address of its Contractor(s) together with a summary of the projects that the Contractor(s) has undertaken that are similar in scope, nature, and value to the *Works* prior to awarding the contract(s) to the Contractor.

In the case where the Contractor has not performed similar *Works and Services* in the District of Summerland, the *Approving Officer* may require that the *Owner* provide a list of projects and references from other local governments that demonstrates that the Contractor(s), site superintendent and inspector is qualified to undertake the *Works and Services*.

- (b) The *Owner* shall ensure that its Contractor(s) constructs the *Works and Services* in accordance with the design, drawings, plans, and specifications approved for *Construction* by the *Director* or designate.

## **1.3 Quality Control and Assurance Plans**

- (a) Quality Control and Assurance Plan
- The *Owner* shall submit or cause the *Consulting Engineer* to submit a Quality Control and Assurance Plan to the *District* for approval coincident with submission of the first design drawing to the *District*.
  - The *Owner's* proposed Design Quality Control and Assurance Plan shall detail the procedures that will be used to ensure and verify that the design for the *Works and Services*, including all plans, drawings, and specifications, shall be completed in accordance with the standards set out in this bylaw.
  - In the case of design items related to pump stations, structures, structural fills, geotechnical or hydro-geotechnical items or any item not described in Schedules 1 - 6, the Design Quality Control and Assurance Plan shall show such specialist and/or sub-consultants with suitable experience in these works.

- The *Owner's* proposed Quality Control and Assurance Plan must detail the procedures that will be used to ensure and verify that the *Works and Services* shall be constructed in accordance with the *Consulting Engineer's* design, plans, drawings, and specifications. The Quality Control and Assurance Plan must include:

A proposed *Construction* Schedule showing milestone dates and the dates of Substantial and Total Performance of the *Works and Services*.

The nature and frequency (periodic or full-time resident) of the proposed site inspections during *Construction* to ensure that all *Works and Services* constructed satisfy the intent of the design and conform with the drawings, plans and specifications.

The nature and frequency of the proposed field and laboratory testing requirements for the *Works and Services* including what materials and equipment are to be tested, what types of tests will be performed and when these tests are to take place.

(b) Record-keeping Quality Control and Assurance Plan

- The *Owner* shall submit or cause its *Consulting Engineer* to submit a Recordkeeping Quality Control and Assurance Plan to the *District* coincident with submission of the first *Design Drawings*.
- The *Owner's* proposed Record-keeping Quality Control and Assurance Plan shall detail the procedures that will be used to ensure and verify that proper records will be kept and maintained throughout the design, *Construction* and warranty phases of the *Works and Services*. The Record keeping Quality and Assurance Control Plan shall ensure that the following records are kept as a minimum:
  - Quality Manual and Standards.
  - Details of any field design or *Construction* changes to the drawings, plans and specifications to which changes are approved in writing by the *District*.
  - Deficiency Identification Forms (Items of the Works that are either not supplied or constructed in accordance with the design (drawings, plans and specifications) or that require remedial or corrective action).
  - Deficiency Disposition/Verification Forms (List of the foregoing Items of the Works that have been corrected).
  - Inspection and Test Records.
  - Field measurement records of completed *Works and Services* that have been used by the *Consulting Engineer* to accurately prepare reproducible as-built drawings that are filed with the *District*.
- Notwithstanding the generality of the foregoing, the *Owner* shall ensure that its *Consulting Engineer* provides the *District* with the following at the times and in the manner set out below:

- Certification prior to paving that it has inspected those items of the Works and Services that are below areas to be paved such as roads, walkways, driveways, and parking lots, and that same comply with the design (drawings, plans and specifications). Such certification shall be accompanied by all test and inspection reports and by video inspections and reports on pipelines.
- Certification prior to acceptance by the *District* that surface works including paving, drainage, curbs and gutters, sidewalks, streetlights, etc. have been constructed in accordance with the design (drawings, plans and specifications).

(c) Record Drawings

- Prior to issuance of a Certificate of Total Performance by the District of Summerland Director of Works and Infrastructure the Applicant must submit with the District of Summerland one complete set of digital Utility Service Records for water and sewer services on District of Summerland forms (provided by the District), one set of original as-constructed drawings, two as-constructed electronic copies of the drawings in a PDF format and one in a .dwg format compatible with the District's requirements.
- All drawings required by this bylaw for works must be prepared, certified and sealed by the Owner's Engineer.

(d) Record Drawing Deficiency Holdback

- Pursuant to Section 7-10 and 7-11 of the Bylaw, the Owner shall provide security in the amount of \$1,000 per sheet (based on approved drawings) for provision of approved Record Drawings, service cards, inspection reports and videos, and all testing results and certifications.

# Schedule C

## District of Summerland DESIGN STANDARDS

### Table of Contents

---

<b>1.</b>	<b>General Design Considerations</b>	<b>1</b>
1.1.	Approved Products	1
1.2.	Specifications and Drawings	1
1.3.	Sustainability and Asset Management	1
1.4.	Independent Utilities	1
1.5.	Utility Rights-Of-Way	2
1.6.	Utility Separation	3
1.7.	Trenchless Technologies	4
1.8.	Seismic Design Standards	4
<b>2.</b>	<b>Water Distribution</b>	<b>6</b>
2.1.	General	6
2.2.	Metering	6
2.3.	Per Capita Demand	7
2.4.	Non-Residential Demand	7
2.5.	Fire Flows	8
2.6.	Design Flows	8
2.7.	Water Pressure	8
2.8.	Hydraulic Design	9
2.9.	Minimum Pipe Diameter	10
2.10.	Dead Ends	10
2.11.	Minimum Depth of Cover	10
2.12.	Grade	11
2.13.	Corrosion Protection	11
2.14.	Valves	11
2.15.	Hydrants	12
2.16.	Blow Offs and Blow Downs	13
2.17.	Test Points	13
2.18.	Air Valves	13
2.19.	Thrust Restraint	14
2.20.	Chambers	14
2.21.	Service Connections	14
2.22.	Alignments and Corridors	15
2.23.	Reservoirs	15
2.24.	Pump Stations	18
2.25.	Pressure Reducing Valve (PRV) Stations	21
2.26.	Hillside Standards	22
2.27.	Drilled Groundwater Wells	22
<b>3.</b>	<b>Sanitary Sewers</b>	<b>24</b>
3.1.	General	24
3.2.	Onsite Sewage Disposal	24
3.3.	Per Capita Flow	25
3.4.	Non-Residential Flows	25
3.5.	Peaking Factor	25
3.6.	Infiltration	26
3.7.	Design Flow	26
3.8.	Pipe Flow Formulas	26
3.9.	Flow Velocities	27
3.10.	Alignment	27
3.11.	Minimum Pipe Diameter	27
3.12.	Minimum Grades	28

# Schedule C

## District of Summerland DESIGN STANDARDS

### Table of Contents

---

3.13.	Curved Sewers .....	28
3.14.	Depth .....	28
3.15.	Manholes .....	29
3.16.	Odour Criteria and Corrosion .....	30
3.17.	Service Connections .....	30
3.18.	Locations and Corridors .....	31
3.19.	Lift Stations .....	32
3.20.	Low Pressure Sewers .....	36
<b>4.</b>	<b>Stormwater Management .....</b>	<b>37</b>
4.1.	General .....	37
4.2.	Design Overview .....	38
4.3.	Runoff Analysis .....	40
4.4.	Site Design .....	45
4.5.	Minor System .....	46
4.6.	Major System .....	57
4.7.	Detention Facilities .....	61
4.8.	Sediment and Erosion Control .....	64
4.9.	Stormwater Quality .....	67
4.10.	Pumping Systems .....	71
4.11.	Hillside Standards .....	71
<b>5.</b>	<b>Roads .....</b>	<b>72</b>
5.1.	General .....	72
5.2.	Road Classifications .....	74
5.3.	Cross-Section Elements .....	75
5.4.	Alignments .....	78
5.5.	Intersections .....	80
5.6.	Roundabouts .....	81
5.7.	Railway Grade Crossings .....	82
5.8.	Traffic Control Devices .....	82
5.9.	Culs-De-Sac .....	82
5.10.	Traffic Barriers .....	82
5.11.	Sidewalk and Pedestrian Crossings .....	82
5.12.	Cycling Facilities .....	83
5.13.	Transit Facilities .....	85
5.14.	Driveways .....	86
5.15.	Clearances .....	86
5.16.	Underground Utility Locations .....	87
5.17.	Pavement Structures .....	88
5.18.	Bridges .....	91
5.19.	Hillside Standards .....	91
5.20.	Traffic Calming .....	93
5.21.	Street Parking .....	94
5.22.	Retaining Wall Systems and Alterations .....	95
<b>6.</b>	<b>Roadway Lighting .....</b>	<b>98</b>
6.1.	General .....	98
6.2.	Codes, Rules, Standards and Permits .....	98
6.3.	Light Sources and Luminaires .....	99
6.4.	Street Lighting .....	99
6.5.	Sidewalk Lighting .....	100
6.6.	Intersection Lighting .....	101



# Schedule C

## District of Summerland DESIGN STANDARDS

### Table of Contents

---

6.7.	Crosswalk Lighting .....	101
6.8.	Walkways.....	102
6.9.	Roundabout Lighting .....	102
6.10.	Tunnel Lighting .....	102
6.11.	Poles.....	102
6.12.	Pole Foundations .....	103
6.13.	Luminaires .....	103
6.14.	Power Supply and Distribution .....	104
6.15.	Design .....	105
<b>7.</b>	<b>Traffic Signals.....</b>	<b>107</b>
7.1.	General.....	107
7.2.	Standardization .....	107
7.3.	Codes, Rules, Standards and Permits .....	108
7.4.	Signal Heads .....	108
7.5.	Pole Placement.....	111
7.6.	Left Turn Phasing.....	111
7.7.	Advanced Warning Flashers .....	112
7.8.	Signal Pre-emption .....	112
7.9.	Audible Pedestrian Signals .....	113
7.10.	Control Types .....	113
7.11.	Detection Methods .....	113
7.12.	Signal Timing Plans .....	114
7.13.	Signal Coordination.....	114
7.14.	Pedestrian Controlled Signals .....	114
7.15.	Poles and Foundations .....	115
7.16.	Controller Cabinets .....	115
7.17.	Controllers .....	115
7.18.	Power Supply and Distribution .....	115
7.19.	Uninterruptible Power Supplies (UPSs).....	116
7.20.	Signs.....	116
7.21.	Drawing Requirements.....	116
<b>8.</b>	<b>Landscaping .....</b>	<b>118</b>
8.1.	Objectives .....	118
8.2.	Related Standards .....	118
8.3.	Application of Standard.....	118
8.4.	Landscape Consultant .....	119
8.5.	Landscape Plan .....	119
8.6.	Boulevards.....	119
8.7.	Medians .....	119
8.8.	Roundabouts, Traffic Circles and Cul-de-sac Islands .....	120
8.9.	Stormwater Management Facilities .....	120
8.10.	Erosion Control .....	121
8.11.	Irrigation.....	121
<b>9.</b>	<b>Electrical, Communications Wiring and Gas Distribution .....</b>	<b>122</b>
9.1.	General.....	122
9.2.	Electrical .....	122
9.3.	Communications and Gas.....	123
9.4.	Utility Locations.....	123
<b>10.</b>	<b>Standard Drawings.....</b>	<b>124</b>

# Schedule C

## District of Summerland DESIGN STANDARDS

### 1. General Design Considerations

---

<b>1. General Design Considerations</b> .....	<b>1</b>
1.1. Approved Products .....	1
1.2. Specifications and Drawings .....	1
1.3. Sustainability and Asset Management .....	1
1.4. Independent Utilities .....	1
1.5. Utility Rights-Of-Way .....	2
1.6. Utility Separation.....	3
1.7. Trenchless Technologies .....	4
1.8. Seismic Design Standards .....	4

---

#### 1. General Design Considerations

##### 1.1. Approved Products

- (a) Acceptable materials are those listed in the *District of Summerland's* Approved Products List. Materials not listed will require permission of the *Director*.

##### 1.2. Specifications and Drawings

- (a) The specifications and drawings found in **Schedule C** shall take precedence over specifications and drawings found in the *MMCD*.

##### 1.3. Sustainability and Asset Management

- (a) Development of appropriate design guidelines for municipal infrastructure involves consideration of the principles of sustainability and asset management. These principles include the following:

- Improve and enhance quality of life;
- Minimize negative impacts on health, safety, and the environment;
- Investigate the impacts of potential actions to manage and mitigate risk;
- Consistently make informed long-term infrastructure decisions; and
- Minimize overall lifecycle investment.

- (b) Some of the above principles involve conflicting priorities, for example undue concentration on financial economies may have adverse impacts on environmental protection and life-cycle costs of infrastructure.

- (c) A balanced approach to design of municipal infrastructure requires careful consideration of all the above principles.

##### 1.4. Independent Utilities

- (a) Independent utilities are those not normally supplied by municipal or regional authorities and are not included in these guidelines. Independent utilities include:

- Electrical power. Power distribution is a municipal utility in Summerland;
- Communications (telephone, cable television, internet); and
- Natural gas.

# Schedule C

## District of Summerland DESIGN STANDARDS

### 1. General Design Considerations

- (b) Design of municipal infrastructure must include consideration of the above utilities. Design of these utilities is normally carried out by the utility *owner* and coordinated for conflicts by the municipal designer and/or the *Director*.
- (c) In new urban *developments*, all wiring is generally to be underground. This excludes electrical transmission lines, which are normally located in separate rights-of-way.

#### 1.5. Utility Rights-Of-Way

- (a) Right-of-way locations shall be selected to avoid environmentally sensitive areas such as *watercourses*, wetlands, wildlife migration corridors and forested areas.
- (b) Rear yard sewers are discouraged and will only be allowed with the permission of the *Director*.
- (c) Where location of a municipal utility in a statutory right-of-way is permitted by the *Director*, the minimum right-of-way widths shall be as follows:

**Table 1.1: Right-of-Way Widths**

Service Type	Right-of-Way Width
Single service	twice the depth from surface to the crown of the pipe [4.5 m minimum width]
Two services within the same trench	twice the depth from surface to the crown of the deeper pipe PLUS trench width [5.5 m minimum width]
Two or more services adjacent to one another but in separate trenches	cumulative widths for single services PLUS any difference to provide the required separation [6 m minimum width]
When the service is within a <i>Road</i> allowance, and the distance from the property line to the centre of the service is less than one half of the width indicated above for a single service, the difference shall be provided as right-of-way on the adjacent property.	
The rights-of-way noted are desirable, but in some cases may not be practical and alternative combined ROW corridors may be required.	

- (d) In all cases, the width of rights-of-way shall be sufficient to permit an open excavation with side slopes in accordance with the WorkSafeBC regulations, without impacting on or endangering adjacent structures.
- (e) Where required, sanitary trunk and interceptor sewers shall have rights-of-way wide enough for future widening and/or twinning. The width of the right-of-way shall be the required separation between pipe centerlines plus 2 times the depth to the crown of the deeper sewer.
- (f) The *Consulting Engineer* shall provide cross sections indicating the minimum safe distances to adjacent building footings based on a safe angle of repose from the limits of the excavation.
- (g) Where a utility is located within a right-of-way, and valves, valve chambers, manholes, or other appurtenances which require maintenance are located within the right-of-way, provide *Road* access from a public *Road*. The maintenance access shall be sufficiently wide and structurally

## 1. General Design Considerations

---

adequate to support the maintenance vehicles for which the access is intended, as determined by the *Director*. Maximum allowable grade of the maintenance access is 12%.

### 1.6. Utility Separation

- (a) Requirements for separation of sanitary or storm sewer from water mains are as follows, unless otherwise indicated by the local public health authority.
- (b) No gas main, electric or telephone duct or other utility line shall be installed in the same trench with water mains.

#### 1.6.1. Horizontal Separation

- (a) At least 3.0 m horizontal separation, measured from closest edge of pipe to closest edge of pipe, shall be maintained between a water main and either a sanitary sewer or a storm sewer.
- (b) In special circumstances, specifically in rock or where the soils are determined to be impermeable, and subject to Interior Health Authority Approval, lesser separation than 3.0 m may be permitted provided that:
- (c) The sewer main and water main are installed in separate trenches and the water main invert is at least 0.5 m above the crown of the sanitary sewer or storm sewer and the joints are wrapped with heat shrink plastic or packed with compound and wrapped with petrolatum tape in accordance with the latest version of AWWA C217, and AWWA C214 or AWWA C209; or,
- (d) The pipes are installed in the same trench with the water main located at one side on a bench of undisturbed soil at least 0.5 m above the crown of the sanitary sewer or the storm sewer and the joints of the water main are wrapped with heat shrink plastic or packed with compound and wrapped with petrolatum tape in accordance with the latest version of AWWA C217, and AWWA C214 or AWWA C209.

#### 1.6.2. Vertical Separation

- (a) Where a sanitary sewer or storm sewer crosses a water main, the sewer should be below the water main with a minimum clearance of 0.5 m and all joints of the water main, over a length extending 3 m each side of the sewer main, are to be wrapped with heat shrink plastic or packed with compound and wrapped with petrolatum tape in accordance with the latest version of AWWA C217, and AWWA C214 or AWWA C209.
- (b) Where it is not possible to obtain the vertical separation indicated above, and subject to *Director* approval, the following details may be used:
  - The water pipe joints should be wrapped as indicated above, and
  - The sewer should be *constructed* of pressure pipe such as high-density polyethylene (HDPE) with fused joints and pressure tested to assure it is watertight.
  - Clearance between manholes should be no less than 0.3 m.

## 1. General Design Considerations

---

### 1.6.3. Sewers in Common Trench

- (a) Storm and sanitary sewers may be installed in a common trench, provided that the design has considered:
- Interference with service connections;
  - Stability of the benched portion of the trench; and
  - Conflict with manholes and appurtenances.
- (b) The horizontal clearance between sewer pipes shall be no less than 1.0 m and the horizontal clearance between manholes shall be no less than 0.3 m.

### 1.7. Trenchless Technologies

- (a) Installation or rehabilitation of pipelines using trenchless methods may be indicated by the designer or required by the Director. The *MMCD* Specifications Section 33.05.23 Trenchless Sewer Pipe Bursting; and *MMCD* Specifications Section 33.05.24 Cured in Place Pipe Liners are two examples of trenchless applications.
- (b) Circumstances favouring trenchless installation include:
- Installation or rehabilitation in heavily built-up areas;
  - Stream crossings;
  - Railway crossings; and
  - *Highway* crossings.
- (c) Available technologies include the following:
- Slip-lining;
  - Cured-in-place pipe (CIPP);
  - Pipe bursting;
  - Horizontal directional drilling (HDD);
  - Microtunnelling; and
  - Pipe jacking.

### 1.8. Seismic Design Standards

- (a) Underground utilities have proven to be prone to high damage rates in a seismic event whenever there are significant permanent ground deformations or excessively high levels of ground shaking and resulting permanent ground accelerations and velocities. Seismic design standards are necessary to be considered in seismically active *zones* with a potential for soil liquefaction. This is even more important when considering a shared fire flow and potable water distribution system, which, during a severe seismic event, is required to remain functional if it is to be relied upon to provide fire suppression throughout the community.
- (b) Design of pressurized distribution systems (water distribution pipes and sanitary forcemains) including small chambers shall be performed in general compliance with ALA Design Guidelines for Seismic Resistant Water Pipeline Installations.

## Schedule C

### District of Summerland DESIGN STANDARDS

#### 1. General Design Considerations

---

- (c) The Pipe Function Class should be established in consultation with the utility operator and be used in evaluating design needs to accommodate seismic events. In addition, use of redundant pipe and frequent isolation valves are recommended on critical infrastructure to increase post-earthquake reliability and help ensure critical pipes, if damaged, can be disconnected from the system without loss of service to other areas.
- (d) This section does not cover seismic design considerations of larger size chambers (typically more than 10 m<sup>2</sup> in footprint), pump station structures, storage tanks, reservoirs and similar large components of the water and sanitary systems. These structures, along with seismically resistant pipe connections, shall be individually assessed by civil, geotechnical, and structural engineers using the latest edition of BC Building Code and application of the Seismic Guidelines for Government to meet post-disaster requirements and other specialty seismic standards applicable to buried and above ground structures

---

<b>2.</b>	<b>Water Distribution .....</b>	<b>6</b>
2.1.	General.....	6
2.2.	Metering.....	6
2.3.	Per Capita Demand .....	7
2.4.	Non-Residential Demand .....	7
2.5.	Fire Flows .....	8
2.6.	Design Flows .....	8
2.7.	Water Pressure.....	8
2.8.	Hydraulic Design.....	9
2.9.	Minimum Pipe Diameter.....	10
2.10.	Dead Ends.....	10
2.11.	Minimum Depth of Cover .....	10
2.12.	Grade.....	11
2.13.	Corrosion Protection .....	11
2.14.	Valves.....	11
2.15.	Hydrants .....	12
2.16.	Blow Offs and Blow Downs .....	13
2.17.	Test Points.....	13
2.18.	Air Valves.....	13
2.19.	Thrust Restraint .....	14
2.20.	Chambers .....	14
2.21.	Service Connections .....	14
2.22.	Alignments and Corridors.....	15
2.23.	Reservoirs.....	15
2.24.	Pump Stations.....	18
2.25.	Pressure Reducing Valve (PRV) Stations .....	21
2.26.	Hillside Standards.....	22
2.27.	Drilled Groundwater Wells .....	22

---

**2. Water Distribution**

**2.1. General**

- (a) These guidelines are not intended to be substitute for sound engineering knowledge and experience. Water distribution system designs should be prepared under the direction of a design professional who has the appropriate experience and is registered with Engineers and Geoscientists of British Columbia.

**2.2. Metering**

- (a) Metering tends to reduce per capita water demands. With the exception of public fire hydrants, blow-offs and blow-downs, provisions should be made for metering of all water connections. Metering shall conform to the *District of Summerland's* Water Utilities Bylaw where locations and system configurations should be chosen such that the meters capture all regular water use. For private fire protection systems including hydrants and/or fire sprinklers, detector check valves should be employed so that illegal connections can be captured and non-revenue water can be eliminated.

- (b) For all single family residential homes without fire sprinklers the water meter size shall be 19mm except in the case where there is a demonstrated need for a larger meter. All other meters should be sized in accordance with AWWA M22. It should be noted that this methodology is based on the fixture value method and not the fixture unit method employed in the BC Building Code for piping within buildings.
- (c) The maximum operating range for a water meter shall be less than 80% of the maximum instantaneous flow capacity as outlined by the meter manufacturer, with a maximum pressure loss of 48 kPa (7 psi) at the design flow rate. The size selection should not compromise the operating range or the long term life of the meter and must ensure that pressures supplied to the property are appropriate for the intended use.
- (d) For *developments* that are proposed to be phased, the meter chamber and piping must be sized for the meter required for the ultimate buildout of the *development*. However, the initial meter installed must be sized to accurately capture the range of flows for the first phase.
- (e) It is expected that in most cases the water meter size will be at least 1-2 sizes smaller than the water service connection, providing they meet the size selection criteria. The Consultant must ensure the meter selection and installation requirements are appropriate for the designed application.

**2.3. Per Capita Demand**

- (a) Estimating water demands should be done based on estimating appropriate flow rates for each land use type. Existing demands should be validated against existing flow meter records. Careful consideration should be given to seasonal population variations in particular for communities with a high percentage of population that is only present seasonally. Furthermore unaccounted for or non-revenue water demands should also be carefully considered and determined if these numbers will remain constant, decrease or increase as population increases.
- (b) In the absence of reliable water consumption records and/or specific municipal requirements, use the following per capita demands for future residential requirements:

Where new *development* is metered:

- Average annual daily demand (A): 900 litres per capita per day (L/c/d)
- Maximum day demand (D): 1,800 litres per capita per day
- Peak hour demand (H): 4,000 litres per capita per day

Maximum day and peak hour demands increase significantly in dry climate areas due to irrigation. Criteria should be adjusted accordingly, based on local water consumption records.

**2.4. Non-Residential Demand**

- (a) Commercial, *industrial* and institutional demands should be determined using specific data related to the *development* or zoning. In the absence of such data, or municipal regulations, use the following for maximum day demands for single story buildings (D):



# Schedule C

## District of Summerland DESIGN STANDARDS

### 2 – Water Distribution

- Commercial or institutional: 22,500 litres per hectare per day
- *Industrial*: 10,000 – 100,000 litres per hectare per day.

Note that the above rates do not include outdoor irrigation and assume that all connections are metered. Agricultural demands should be determined using specific data, in the absence of specific data, use the following maximum day demands:

- Agriculture: 6 G.P.M.

#### 2.5. Fire Flows

- (a) Fire flows should be determined in accordance with the requirements of the current edition of "Water Supply for Public Fire Protection – A Guide-to Recommended Practice", published by Fire Underwriters Survey.

Fire flows are also subject to the following minimum requirements (Table 2.5):

**Table 2.5: Minimum Fire Flow Requirements**

Developments (without sprinklers)	Minimum Fire Flow / Duration
Single Family Residential	60 L/s for 2.0 hours
Apartments, Townhouses	90 L/s for 2.0 hours
Commercial	150 L/s for 2.5 hours
Institutional	150 L/s for 3.0 hours
Industrial	225 L/s for 3.0 hours

- (b) Actual required fire flows should be determined for all new *developments* using FUS calculations. Fire flow calculations for building *development* with sprinklered fire protection shall be designed in conformance the BC Fire Code and with NFPA standards, in particular NFPA 13, Automatic Sprinkler Systems Handbook.

#### 2.6. Design Flows

- (a) Unless otherwise indicated by the *District of Summerland*, system design flows should be based on the ultimate population and fully developed non-residential land as anticipated in the Official Community Plan (*OCP*).
- (b) Total design flows ( $Q_{design}$ ) are to be greater of the following:
- $Q_{design} - D+F$  Maximum Day Demand plus the Fire Flow, or
  - $Q_{design} - H$  Peak Hour Demand
- (c) For larger system analysis it is recommended that diurnal curves be applied to each use type to avoid the overly conservative method of assuming all peaks occur at the same time.

#### 2.7. Water Pressure

Maximum allowable pressure	850 kPa*(125 psi)
Minimum pressure at Peak Hour Demand (H)	250 kPa (36 psi)
Minimum pressure in system during design	

fire flow and Maximum Day Demand (MDD+FF) 140 kPa (20 psi)

\*Subject to approval of the *Director*, the maximum allowable pressure may be increased to 1035 kPa (150 psi) for systems with multiple pressure zones.

- (a) Where the maximum pressure exceeds 515 kPa (75 psi), service connections must be individually protected by pressure reducing valves located in the buildings being served.
- (b) Determination of pressure limits should include consideration of property elevations relative to street level.

**2.8. Hydraulic Design**

- (a) Use a proven network analysis computer model based on the Hazen-Williams formula:

$$Q = \frac{CD^{2.63}S^{0.54}}{278780}$$

Where: Q = Rate of flow in L/s  
 D = Internal pipe diameter in mm  
 S = Slope of hydraulic grade line in m/m  
 C = Roughness coefficient  
 130 for all new pipes

- (b) Roughness coefficients for existing pipes should be based on friction factor testing. As a reference the following coefficients have been published by AWWA M32 for various pipe materials (Table 2.8).

**Table 2.8 Roughness Coefficient for Various Pipe Materials**

Pipe Material	C Factor
PVC and PE	140-150
Cement Lined Ductile Iron, Cement Lined Steel, Asbestos Cement	135-140
Unlined Cast Iron	80-120

It should be noted that the values listed in the above table are for pipe losses only and do not include losses associated with fittings, tees and valves.

Other formulas and methods may be used subject to *Director* approval.

- (c) The maximum allowable design velocity under peak hour flow conditions should be 2.0 m/s. Velocities under fire flow conditions should be below 4.0 m/s to avoid excessive surge pressures.
- (d) When watermains cross railroads, major regional *roads* including Provincial *Highways*, or *watercourses*, a steel carrier pipe must be provided and must be designed to all applicable static, dynamic and seismic loadings and all other requirements of the authority having jurisdiction. The size of the casing pipe must be at least the greater of 25% or two diameters larger than the outside diameter of the watermain pipe bell or pipe, respectively. Service connection crossings across *highways* and railroads are not recommended.

- (e) The maximum length of any permanent, non-interconnected watermain shall not exceed 200m in length. All mains exceeding 200m in length, unless it is a temporary situation, must be looped.
- (f) Where there is an existing hydraulic network model in place, the *District of Summerland* will provide information for design calculations for the fee noted in the Water Utilities Bylaw.
- (g) Depending on the complexity and extent of the proposed water distribution system, the *District of Summerland* may require a hydraulic analysis showing minimum design flows and pressures.
- (h) Where the water system network is deficient, installation of supplementary mains may be required and may necessitate the provision of rights of way in favour of the *District of Summerland* or the agency having jurisdiction.

**2.9. Minimum Pipe Diameter**

- (a) Distribution mains: 200 mm\*  
Fire hydrant connections: 150 mm  
\*\*Service connections: 19 mm  
With fire sprinklers 37 mm (single family residential)  
With fire sprinklers 50 mm (other than single family residential)

\* For looped distribution mains with lengths less than 500 m in residential *subdivisions*, the diameter can be reduced to 150 mm, providing that fire flow requirements can be met.

\*\*Sprinklers may be permitted in areas located outside of the *District's* 10 minute fire response area at the discretion of the *Director*.

Subject to approval of the *District of Summerland*, distribution main minimum diameter may be reduced to 150 mm provided that the main terminates in a short residential *cul-de-sac*, has a length less than 80 m and serves no fire hydrants or fire sprinkler systems.

**2.10. Dead Ends**

- (a) Water mains must be looped wherever possible. Where dead ends are unavoidable, and approved by the *Director*, an air valve and blow-offs or blow-downs should be provided. Blow-off and blow-down sizes are:
  - 50 mm dia. for 100 and 150 mm dia. water mains
  - 100 mm dia. for 200 mm dia. and larger water mains

Where practical, the *Director* may require a hydrant instead of a blow-off.

**2.11. Minimum Depth of Cover**

- (a) Water mains and services must be of sufficient depth to:
  - Prevent freezing. Soil type and groundwater levels should be considered. Minimum depth within the *District of Summerland* is 1.5 m.
  - Clear other underground utilities.

- Provide mechanical protection from external loads.
- Minimum cover: 1.5 m except where otherwise indicated by *Director*.

(b) Special consideration is required for frost and mechanical protection in cases where minimum depths cannot be attained, e.g. at bridge crossings and in chambers.

## **2.12. Grade**

(a) Grades should be straight lines between defined deflection points. Elevations should be recorded.

(b) Where possible, the minimum grade of water mains should be 0.1%. Grading should be designed to minimize the number of high points.

(c) When the slope equals or exceeds 20%, provide anchorage, joint restraints, trench dams and trench drainage. Provide geotechnical engineering report where appropriate.

## **2.13. Corrosion Protection**

(a) Where there is a potential for encountering corrosive soils, a geotechnical corrosion analysis on the alignment of any proposed metallic watermain or metallic appurtenances should be conducted to determine the corrosiveness of the native soils. If the soils are determined to be corrosive, measures such as cathodic protection and other measures may be considered. One example is *MMCD* Specification Section 26 42 13, Cathodic Protection.

## **2.14. Valves**

(a) In general, valves should be located as follows:

- In intersections either in a cluster at the pipe intersection or at projected property lines to avoid conflicts with curbs and sidewalks:
  - Min. 3 valves at “X” intersection
  - Min.2 valves at “T” intersection
- Not more than 200 m apart (except on feeder mains where spacing can be increased to 800 m)
- Not more than 1 hydrant isolated
- Not more than 20 service connections isolated

(b) In order to permit the use of pigging cleaning methods the valve sizing and type selection should be as follows:

- The valves shall be the same diameter as the watermain up to 300 mm diameter
- The main line valves on mains 350 mm and 400 mm diameter may be smaller by one (1) size with the use of proper reducers
- The main line valves on mains 450 mm diameter and larger may be smaller by two (2) sizes with the use of proper reducers
- Geared operators, with risers and extension rods and a valved by-pass for equalizing pressures shall be provided on main line gate valves 350 mm diameter and larger

- Unless use of butterfly valves is approved in advance, with appropriate bypass piping all valves shall be gate valves

**2.15. Hydrants**

- (a) Fire hydrants should be located in general at street intersections and as follows:
- Not more than 180 m apart and not more than 90 m from a building.
  - in accordance with “Water Supply for Public Fire Protection - A Guide to Recommended Practice”, published by Fire Underwriters Survey.
  - 2.0 m back from curb or 0.5 m back of sidewalk.
  - Minimum 3.0 m clear of any other utility structure.
  - At property lines in mid-block locations.
- (b) Fire hydrant spacing and location must be submitted to the Fire Department for review and comment.
- (c) The *Director* may with the Fire Chief or designate:
1. adjust hydrant locations as deemed necessary;
  2. adjust the spacing distances slightly if it is deemed necessary to avoid obstructions;
  3. adjust the spacing distances slightly if the adjustment does not negatively impact fire fighting capabilities or effectiveness;
  4. require additional hydrants if the additional hydrants are deemed necessary to improve fire fighting capabilities or effectiveness to the proposed *subdivision* or *development*.
- (d) In general, if the flow from the hydrant does not exceed 60 L/s the hydraulic head required at the water main upstream of the hydrant is 14 m. If the required flow from a single hydrant exceeds 60 L/s, the hydraulic head required at the watermain upstream of the fire hydrant must be greater to account for the head losses through the hydrant. The minimum hydraulic head immediately upstream of the watermain required for a single hydrant delivering fire flows is as follows (Table 2.15)

**Table 2.15 Minimum Hydraulic Head Requirements**

Flows (l/s)	Minimum Hydraulic Head at Water Main/Nearest Node Required (m)
45	14.0
60	14.0
90	15.8
120	22.6
150	31.4

- (e) For flow rates not detailed above, and for situations where multiple hydrants are required to deliver the fire flow, the minimum hydraulic head can be calculated as the greater of 14 m and 7 m plus the head loss through the hydrant. However, regardless of the fire flow delivered, the minimum hydraulic head at the watermain or the nearest node must be 14 m.
- (f) Head loss through the hydrant(s) should be calculated as:

$$HL = 1,083 \times Q^2$$

Where: HL – head loss (m)  
 Q – fire flow (m<sup>3</sup>/s)

- (g) The minimum hydraulic head for all nodes of the system should be at least 14 m during fire flow events.

**2.16. Blow Offs and Blow Downs**

- (a) Blow offs shall be provided at the ends of all dead end mains. For 200mm and larger mains, blow offs require special design.
- (b) On all mains greater than 350 mm diameter, install blowdowns at the lowest point in the pipeline profile between the line valves.
- (c) Blow offs are required at the end of all water mains and must be *constructed* and installed in accordance with the Standard Drawings. Where deemed necessary by the *Director*, a fire hydrant will be required instead of a blow off on mains 150 mm diameter or larger.

**2.17. Test Points**

- (a) Test points shall be installed on all water mains in order to provide for the ability to collect water samples in accordance with AWWA C651. Test points shall be Kupferle Eclipse #88 SS sample station with five (5) feet minimum deep bury option and minimum 29 inch high pedestal.

**2.18. Air Valves**

- (a) Combination air valves must be installed at all dead ends and at the summits of all mains of 150 mm diameter and larger, except as follows:
  - Where the difference in elevation between the summit and valley is less than 600mm
  - Where it can be shown that air pockets will be carried by typical flows
  - Where active service connections are suitably located to dissipate entrapped air.
- (b) In addition, valves should be sized and located where necessary to protect the watermain from transient conditions/water hammer.
- (c) Typical air valve sizes, subject to design analysis, are as follows (Table 2.18):

**Table 2.18 Typical Air Valve Sizes**

Watermain Size	Valve Size
150 mm to 300 mm	25 mm
350 mm to 600 mm	50 mm
Larger than 600 mm	Special Design

- (d) Air valves must be vented to an appropriate secured above-grade location to eliminate any potential for cross connection in a flooded or contaminated chamber. The designer should

consider specifying direct bury style air valves where possible to avoid using a valve chamber and having a confined space.

- (e) Double acting air and vacuum relief valves must be installed at all summits in the mains. Air valves must be designed to protect the pipe from transient conditions. In no case shall the size be less than 25 mm. Air valves must be *constructed* and installed in accordance with the Standard Drawings.

## **2.19. Thrust Restraint**

- (a) Concrete thrust blocking and/or adequate joint restraining devices must be provided at bends, tees, wyes, reducers, plugs, caps, valves, hydrants and blow-offs. All hardware must be stainless steel.
- (b) The restraint system must take into account potential future excavations in the vicinity of the water main. Design calculations must be based on fitting type, water pressure and soil conditions.

## **2.20. Chambers**

- (a) Chambers or manholes containing valves, blow-offs, meters, or other appurtenances should be avoided. If approved by the *Director*, chambers and manholes shall provide adequate room for maintenance, including headroom and side room. Access openings must be suitable for removing valves and equipment. The chamber is to be provided with a drain to a storm sewer or ditch, complete with backflow prevention, to prevent flooding of the chamber. Rock pits may be considered subject to suitable soil and groundwater conditions. A pumping system may be required for drainage.
- (b) Adequate venting should be provided. The *District of Summerland* may require provision of forced ventilation, lighting, heating and dehumidification. Access and ventilation details must comply with WorkSafeBC requirements.
- (c) Insulation to prevent freezing should be provided where necessary.

## **2.21. Service Connections**

- (a) Service connection size should be calculated on the basis of the designated land use including sprinkler systems and/or on-site hydrants, where applicable. The minimum size is outlined in 2.9 - Minimum Pipe Diameter.
- (b) Each service should have a shut-off located within 300 mm of the property line on the public side. Each connection of 100 mm dia. or larger requires a check valve at the property side of the shut-off.
- (c) The curb stop at the end of each service pipe must be located 2.0 meters from the property corner pin. Where such location will conflict with other services in the alternate alignments may be submitted for approval.

- (d) All Service connections tapped directly into mains must be made using double strap service saddles or full wraparound saddles. Multiple corporation stops must be staggered. All materials must be non-corrosive.
- (e) All new service connections should have provisions for metering.
- (f) Curb stop operating rods shall be stainless steel.
- (g) Separate water services installed in accordance with the Standard Drawings must be provided to each *parcel* and installed on the same side of the *parcel* as the sanitary sewer service. Water services to *District of Summerland Parks* must be *constructed* and installed in accordance with Standard Drawings.

## **2.22. Alignments and Corridors**

- (a) On straight *roads*, watermains should have straight alignments with uniform offsets between intersections. For curved *roads* and alignments, design joint deflections should be limited to half the maximum deflection specified by the pipe manufacturer.
- (b) Mains should be located such that each property served has at least one side facing the watermain.
- (c) Where a watermain crosses private land, right-of-way requirements are as indicated in Section 1.0, General Design Considerations.
- (d) Clearance from sewers is as indicated in Section 1.0, General Design Considerations.

## **2.23. Reservoirs**

### **2.23.1. Preliminary Design**

- (a) Reservoir design should include a commissioning plan and a preliminary design report which is to be approved by the *District of Summerland* before detailed design begins. Preliminary designs should cover the following issues:
  - (i.) Use of concrete material
  - (ii.) Ease of operations and an Operational Schematic
  - (iii.) Connection to telemetry
  - (iv.) Design standards
  - (v.) Volume
  - (vi.) Shape
  - (vii.) Number of cells
  - (viii.) Geotechnical report on foundations conditions
  - (ix.) Appearance
  - (x.) Water Quality and reservoir mixing
  - (xi.) Confined space avoidance and/or isolation methods to be utilized for entering confined spaces that are in compliance with Part 9 of the OHS Regulation
  - (xii.) Post disaster building provisions to comply with the latest BCBC



**2.23.2. Capacity**

- (a) Reservoirs should be designed to suit the particular circumstances. Reservoir capacity should be calculated by the following formula:

$$\text{Total Storage Volume} = A + B + C$$

Where:           A = Fire Storage (from Fire Underwriters Survey guide)  
                      B = Equalization Storage (25% of Maximum Day Demand)  
                      C = Emergency Storage (25% of A+B)

- (b) Subject to the results of a detailed engineering analysis, and approval of the *District of Summerland*, the requirement for emergency storage (C) may be reduced or eliminated based on consideration of the following:
- (i.) Dependability of water source.
  - (ii.) Reliability of the supply system.
  - (iii.) Presence of more than one supply source.
  - (iv.) Whether the reservoir is part of a large system.
  - (v.) Presence of other reservoir(s) in system.
  - (vi.) Availability of standby power.
  - (vii.) The need for adequate circulation of reservoir water to maintain quality.

**2.23.3. Structural Design Codes**

- (a) Design in accordance with the latest edition of the BC Building Code and one of the following specialty codes:
- (i.) ACI 350/350R: Code Requirements for Environmental Engineering Concrete Structures, and Commentary.
  - (ii.) PCA: Circular Concrete Tanks Without Prestressing
  - (iii.) ACI 350.3/350.3R: Seismic Design of Liquid Containing Concrete Structures, and Commentary
  - (iv.) AWWA D110: Wire and Strand-Wound Circular Prestressed-Concrete Water Tanks
  - (v.) AWWA D115-06 Tendon-Prestressed Concrete Water Tanks

**2.23.4. Design Features**

- (a) Seismic Loading: Design for the following:
- (i.) Watertight structure and fully operational mechanical equipment, following a 475-year return period earthquake.
  - (ii.) Repairable damage and no uncontrolled release of water following a 2475-year return period earthquake.
- (b) Two cells, each containing one-half of total required volume and capable of being drained and filled independently.

## Schedule C

### District of Summerland DESIGN STANDARDS

#### 2 – Water Distribution

---

- (c) Overflow drain sized to handle the maximum design inflow. Overflow drain to be equipped with a manhole with provisions for dechlorinating water prior to release to the environment.
- (d) Separate inlet and outlet pipes located and oriented to provide circulation within the reservoir.
- (e) Independent drain outlet at bottom, with consideration given to discharge route, capacity and environmental concerns.
- (f) Roof access hatch sized (min. 1m x 1m) and located for safe and convenient access for personnel, parts, temporary ventilation facilities and cleaning equipment into each cell.
- (g) Hatches: watertight aluminum, complete with hinges and related hardware, drains, locks and intrusion alarms.
- (h) Broomed non-slip surface on top of reservoir with appropriate grate to ensure water drains off.
- (i) Ventilation pipes or openings sized to handle appropriate intake and exhaust air volumes for filling and draining the reservoir. Include security considerations designed to prevent the intrusion of birds, vermin and dust.
- (j) Reservoir floor to slope to drain sump in concrete structures.
- (k) Drain sump in concrete reservoirs to be minimum 1000 mm x 1000 mm x 400 mm; invert of drain pipe to be flush with sump floor; grating to be installed over sump.
- (l) *Zoned* sub-drains under floor to collect, drain and allow monitoring of any leakage.
- (m) Stairways or stainless steel interior wall ladder from roof access to floor. All ladders and stairs to meet WorkSafeBC regulations, including attachment points for fall arrest equipment.
- (n) Fall prevention railings.
- (o) DBI Sala davit base for confined space and entry rescue.
- (p) All pipework within the reservoir to be PVC, stainless steel, fibreglass or steel or ductile iron coated to AWWA standards.
- (q) All metal parts within the reservoir including bolts, nuts, screws, anchors, ladders, etc. to be stainless steel.
- (r) Pressure transducer or ultrasonic level controls for each cell.
- (s) Sample lines for at least one sample per 1000 m<sup>3</sup> volume within each cell.
- (t) Washdown connection in each cell, complete with backflow preventer and 65 mm diameter pipe.
- (u) Convenient maintenance access.

- (v) Fencing, lighting, locks, alarms and other security facilities to minimize vandalism and prevent water contamination.
- (w) Site finishing and grading to suit location and surrounding land uses.

### **2.23.5. Valve Kiosk or Building**

- (a) Reservoir piping is to incorporate a Valve Kiosk or Building with the following design features:
  - (i.) A above ground kiosk or small building must be *constructed* to house all valving associated with reservoir operations
  - (ii.) Provide structure details including access provisions
  - (iii.) Design in accordance with seismic codes noted above.
  - (iv.) Entrance to be large enough to permit safe removal of largest equipment.
  - (v.) Lifting beams and hoists where necessary to enable removal of equipment
  - (vi.) Space for safe and convenient operating and maintenance access to all valves, piping, equipment and instrumentation.
  - (vii.) Interior and exterior of all steel piping to be epoxy coated to AWWA standards, or use stainless steel. Steel pipe in contact with potable water to use products that are NSF 61 certified.
  - (viii.) Floor drains and drainage system.
  - (ix.) Located above 200-year flood level or 1.0 m above highest recorded flood elevation.
  - (x.) HVAC, lighting & receptacles
  - (xi.) Surge protection
  - (xii.) Instrumentation & Controls
- (b) Additional features, which may be required subject to system operations details, include the following:
  - (i.) Sampling ports for inlet, outlet and reservoir water.
  - (ii.) Flow measurement and recording.
  - (iii.) Heat, light and ventilation to local and WorkSafeBC standards.
  - (iv.) PLC-controlled inlet valve and level monitoring and control system.
  - (v.) Connection to SCADA system
  - (vi.) Uninterruptible power supply (UPS) for control system (minimum 60 minutes)
  - (vii.) Chlorine residual analyzer for reservoir inlet and outlet.
  - (viii.) Provision for re-chlorination facilities.
  - (ix.) The designer is to provide three copies of a comprehensive Operations and Maintenance Manual and a commissioning plan.

## **2.24. Pump Stations**

### **2.24.1. Preliminary Design**

- (a) Pump station design must include a commissioning plan and a preliminary design report which is to be approved by the *District of Summerland* before detailed design proceeds. Preliminary designs should include the following issues:

- (i.) Location
- (ii.) Capacity
- (iii.) Hydraulics (pressure, NPSH, pump RPM, efficiencies)
- (iv.) Water hammer analysis and mitigative measures
- (v.) Number and type of pumps
- (vi.) Preliminary piping layout
- (vii.) Type and appearance of structure
- (viii.) Foundation conditions
- (ix.) Maintenance requirements and access
- (x.) Energy requirements
- (xi.) Standby power
- (xii.) HVAC including AC
- (xiii.) Controls and monitoring
- (xiv.) Aesthetics and site grading
- (xv.) Life cycle costs
- (xvi.) Operations
- (xvii.) Confined space avoidance and/or isolation methods to be utilized for entering confined spaces that are in compliance with Part 9 of the OHS Regulation
- (xviii.) Post disaster building provisions to comply with the latest BCBC

### **2.24.2. Capacity**

- (a) Pumping capacity should be designed to suit the particular circumstances. In general, capacity should meet maximum day demand with the largest pump out of service and balancing storage on line. If balancing storage is not on line, pumping capacity should meet peak hour demand with the largest pump out of service. Stand-by power should be provided, where sufficient reservoir storage does not exist, to allow the greater of maximum day demand plus fire flow or peak hour demand (D+F, or H) during a power outage.

### **2.24.3. Design Features**

- (a) Structure, piping and mechanical systems designed in accordance with seismic codes for post-disaster structures
- (b) Located above 200-year flood level or 1.0 m above highest recorded flood elevation.
- (c) Reinforced concrete, blockwork or brick *construction* designed to incorporate aesthetic considerations.
- (d) Access doorways sized for safe and convenient removal and replacement of the largest piece of equipment. Lifting hooks or rails with pulley blocks as required.
- (e) Adequate HVAC and lighting.
- (f) Standby power, unless fire storage and balancing and/or emergency storage is available without pumping.
- (g) Electric motors to be 600 volt, 3 phase, premium efficiency, with thermal protection. Lower voltage (208V, 3 phase) may be considered, depending upon service voltage available from power company.

## Schedule C

### District of Summerland DESIGN STANDARDS

#### 2 – Water Distribution

---

- (h) Electrical motors to be equipped with Variable Frequency Drive (VFD).
- (i) Minimum 60 minute uninterrupted power supply (UPS) for control systems.
- (j) Motors 100 hp and above to have analog vibration recording and protection.
- (k) Air relief discharge and pilot lines to be piped to floor drains.
- (l) Housekeeping pads for MCCs.
- (m) Hydraulically operated or motorized pump control valves with isolation valves, unless pumps have variable speed drives which control transient pressures.
- (n) Flow meters and totalizers.
- (o) Spring return “Silent” check valves.
- (p) High pressure and surge relief valves with isolation valves, if warranted by system characteristics and transient analysis.
- (q) Suction and discharge pressure gauges, with isolation valves, for each pump.
- (r) Discharge pressure transducer for connection to SCADA
- (s) Mechanical pump seals.
- (t) Water quality sampling ports.
- (u) Interior and exterior of pipework epoxy coated to AWWA standards, or use stainless steel. Steel pipe in contact with potable water to use products that are NSF 61 certified.
- (v) Pump system to be PLC-controlled and connected to SCADA system, if applicable.
- (w) Surge protection
- (x) Hour meters and ammeters for each pump.
- (y) Power factor correction, if required by power company.
- (z) 120 V power outlet for small tools
- (aa) Noise attenuation to suit the location and *District of Summerland* standards.
- (bb) Equipment to be CSA approved and have minimum one-year guarantee on parts and labour. All equipment must be tested prior to acceptance.
- (cc) Arc flash study and labels per current electrical code.
- (dd) Off *road* vehicle parking.

- (ee) Site finishing and grading to suit location and surrounding land uses.
- (ff) Designer to provide a commissioning plan and schedule.
- (gg) Designer is to provide three copies of a comprehensive Operating and Maintenance Manual. The manual must contain an operation and control narrative.

## **2.25. Pressure Reducing Valve (PRV) Stations**

- (a) PRV station design must include a preliminary design report that addresses the design criteria of this bylaw is to be approved by the *District of Summerland* before detailed design proceeds.

### **2.25.1. Preliminary Design Parameters**

- (a) Design Flows:
  - peak hour,
  - maximum day plus fire.
  - Continuous, emergency or fire flow operation.
  - Location.
- (b) Above Ground Kiosk details:
  - structure and access,
  - controls and monitoring,
  - HVAC, and
  - Lighting.

### **2.25.2. Design Features**

- (a) PRV to be above ground and as minimum contain at least two compartments including:
  - 1) Process Compartment, and
  - 2) Electrical Compartment including 2 hinge style doors on each long side of the structure, hinged roof, and floor drain.
- (b) Minimum kiosk size: 4.1 m length x 1.6 m wide x 2.3 m high (inside dimensions).
- (c) Minimum 30 amp, 120 VAC electrical service
- (d) Surge protection
- (e) Forced air ventilation, heat, lighting and receptacles
- (f) Parallel pressure reducing valves, one sized for peak hour and maximum day plus fire flows during irrigation seasonal flows and one sized for non-irrigation season flows.
- (g) Isolating valves.

## Schedule C

### District of Summerland DESIGN STANDARDS

#### 2 – Water Distribution

---

- (h) Include port on upstream side of inlet isolation valve for pilot water supply
- (i) Include duplex strainer system for pilot water supply
- (j) All pilot lines to include ball valves for isolation of individual components
- (k) Drain ports on bottom of pipe with ball valves on inside of main line isolation valves for flushing/draining 1" minimum.
- (l) Air release valves.
- (m) Off street parking.
- (n) Basket strainers upstream of each control valve.
- (o) Upstream and downstream pressure gauges and transducers.
- (p) Flowmeter.
- (q) Interior and exterior of pipework epoxy coated to AWWA standards for piping over 150mm diameter and use stainless steel for smaller than 150mm. Steel pipe in contact with potable water to use products that are NSF 61 certified.
- (r) PLC-controlled with connection to SCADA system, if applicable, including:
  - Discharge and suction pressure transmitters
  - Flow transmitter
  - Uninterruptible power supply (UPS) for 60 minute minimum
  - Operator interface panel
- (s) Designer is to provide three copies of a comprehensive Operating and Maintenance Manual.

#### 2.26. Hillside Standards

- (a) As per the requirements outlined in **Section 5.19 – Hillside Standards**, the following water considerations shall be included in designated *hillside* areas:
  - (i.) water system pressure *zone* boundaries shall be designed to ensure fire fighting pressures in the high side of the *lots* and top floor sprinkler systems for building *development*.

#### 2.27. Drilled Groundwater Wells

- (a) If a *subdivision* is to be serviced with a drilled well water source (per Levels of Service **Table A.1**), each *parcel* must be serviced with a potable water supply. Where the water source is not located on the *parcel* it will service, the location and access to the water source, including any wells, water mains, and all other appurtenances, shall be protected by an easement.

- (b) Unless exempted by this bylaw, a water sample must be taken from the water source and tested by a laboratory accredited by the Canadian Association for Environmental Analytical Laboratories to determine conformity to potable water standards. Potable water must be verified in writing by a Qualified Water Quality Specialist and the results must be submitted to the *District*.
- (c) If the water is determined to be not potable, but can be treated in such a manner that it becomes potable as determined by a Qualified Water Quality Specialist, a Section 219 Covenant must be registered on the title of the subject property as a priority above financial charges stating that an occupancy permit for a dwelling will not be issued until a treatment system meeting the specifications of a Qualified Water Quality Specialist has been installed to ensure a potable water supply.
- (d) All hydrogeological reports, pumping tests, and well yield tests must be dated not more than five (5) years prior to the date of *subdivision* application.
- (e) Proof of water shall consist of the following:
  - (i.) A site plan must be provided indicating the location of a *constructed* well which must be tested by a well yield test conducted by a Qualified Well Driller, Qualified Well Pump Installer or a person working under the direct supervision of a Qualified Well Driller, a Qualified Well Pump Installer, or Qualified Professional.
  - (ii.) The well yield test must be submitted to the *District*. A well that demonstrates a yield of at least 14 Litres per Minute (3.0 Imperial Gallons per Minute) satisfies the proof of water quantity requirements of this bylaw.
  - (iii.) The *Director* may allow for a pumping test to be carried out when a well yield test reports less than 14 Litres per Minute (3.0 Imperial Gallons per Minute) or when a well is less than 15 m deep. A pumping test must be conducted by a Qualified Well Driller or a Qualified Well Pump Installer or a person working under the direct supervision of a Qualified Well Driller, a Qualified Well Pump Installer or a Qualified Professional. A hydrogeological report must be prepared by the Qualified Professional and submitted to the *District*.
  - (iv.) Pumping tests of all drilled wells shall be conducted during the dry months of the year, defined as the period between August 1 and March 1, or at another time of year as confirmed in writing by the Qualified Professional in order to determine the year-round capacity of the well.
  - (v.) When a pumping test is required, the report must demonstrate that the drilled well can provide at least 6,550 litres of water per day (1.0 Imperial Gallon per Minute) per *parcel*. The report must demonstrate that the use of the well will not negatively impact the use of neighbouring wells.



<b>3. Sanitary Sewers.....</b>	<b>24</b>
3.1. General.....	24
3.2. Onsite Sewage Disposal.....	24
3.3. Per Capita Flow.....	25
3.4. Non-Residential Flows.....	25
3.5. Peaking Factor.....	25
3.6. Infiltration.....	26
3.7. Design Flow.....	26
3.8. Pipe Flow Formulas.....	26
3.9. Flow Velocities.....	27
3.10. Alignment.....	27
3.11. Minimum Pipe Diameter.....	27
3.12. Minimum Grades.....	28
3.13. Curved Sewers.....	28
3.14. Depth.....	28
3.15. Manholes.....	29
3.16. Odour Criteria and Corrosion.....	30
3.17. Service Connections.....	30
3.18. Locations and Corridors.....	31
3.19. Lift Stations.....	32
3.20. Low Pressure Sewers.....	36

**3. Sanitary Sewers**

**3.1. General**

- (a) These guidelines are not intended to be a substitute for sound engineering knowledge and experience. Sanitary sewer system designs should be prepared under the direction of a design professional who has the appropriate experience and is registered with Engineers and Geoscientists of British Columbia.
- (b) Sanitary sewers are intended to convey wastewater only. This includes standard domestic plumbing fixtures, floor drains, approved *industrial* and commercial wastes and unavoidable infiltration. Sanitary sewer systems are intended to exclude stormwater, roof drains, footing drains and groundwater.
- (c) These guidelines apply to *District* sewage collections systems only. For large land *parcels* (>1Ha), on-site sewage disposal may be permitted, subject to approval by the *Director* and regional and/or provincial health authorities.

**3.2. Onsite Sewage Disposal**

- (a) If a *subdivision* is to be serviced with an onsite sewage disposal system, as approved by the *Director*, the onsite sewage disposal system must be capable of being provided for each proposed *lot* in accordance with Interior Health Authority (IHA), Okanagan Basin Water Board (OBWB) and *District of Summerland* standards.

## Schedule C

### District of Summerland DESIGN STANDARDS

#### 3 – Sanitary Sewer

- (b) For proposed *lots* greater than 1 ha and smaller than 2 ha in size, written confirmation from IHA and OBWB must be submitted to the *District* stating that their requirements with regard to onsite sewage disposal have been satisfied.
- (c) Notwithstanding the above, a *parcel* must not be serviced by onsite sewage disposal if a community sanitary sewage system is available to service the property or the *parcel* is smaller than 1 Ha in size.
- (d) Shared onsite sewage disposal systems are not permitted.

#### 3.3. Per Capita Flow

- (a) In absence of sanitary sewer flow records, sanitary sewer system design for new fully water metered systems should be based on an average daily dry weather flow (ADWF) of 240 litres per day per capita (L/d/c).
- (b) For unmetered systems the ADWF of 350 L/d/c should be used.
- (c) Sanitary sewer system design shall be based on an average daily dry weather flow (ADWF) of 300 litres per *Day* per capita (L/d/c).
- (d) For residential areas, the land use densities in **Table 3.1** shall apply.

**Table 3.1: Land Use Densities**

	People/Gross Ha.	People/Unit
Residential Low	Up to 66	2.35
Residential medium	Up to 140	2.35
Residential High	140 and up	2.35

#### 3.4. Non-Residential Flows

- (a) Average dry weather flows (ADWF) for non-residential areas shall be based on specific data related to the *Development* or *Zoning*. In the absence of such data or local regulations, use the following flow values which are based on fully water metered systems (**Table 3.2**):

**Table 3.2: Flow Values for Non-Residential Areas**

Land Use	Equivalent Population/Hectare (gross)
Commercial:	25,000 litres/ha/day
Institutional:	25,000 litres/ha/day
Industrial:	25,000 litres/ha/day

#### 3.5. Peaking Factor

- (a) The peaking factor is the ratio of peak dry weather flow (PDWF) to the average dry weather flow (ADWF). Where possible, the peaking factor should be based on locally recorded flow data from similar *developments*. It is recommended that if possible residential equivalents not be used but that each customer type calculates peak flows independently. When using hydraulic modelling software, it is recommended that diurnal patterns be used that reflect varying time of day flows

from each customer class. In the absence of such data, the peaking factor is to be calculated using the design residential population and non-residential equivalent population, with the formula indicated below:

$$PF = \frac{3.2}{(P)^{0.105}}$$

Where: PF = peaking factor  
 P = residential population plus non-residential equivalent population.

**3.6. Infiltration**

(a) Design flows shall include an infiltration allowance to allow for groundwater infiltration and system inflows as follows. For urban, suburban or commercial areas, the allowance should be based on the gross tributary area and the following:

- New system with pipes above groundwater table: 0.06 L/s/ha
- Old system (25 years or older) and/or pipes below groundwater table: 0.12 L/s/ha

(b) The above values are based on systems where roof leaders and foundation drains are not connected to the sanitary sewer.

(c) For older systems it is recommended that the above value be confirmed with flow monitoring since in some systems this value can be substantially higher.

(d) For low density areas with large *lots* (>90 m *frontage*), or spaces between developed areas, the infiltration allowance should be based on the total sewer system pipe sizes and lengths, including sewer mains, service connections and building sewers, and the following:

- New system with pipes above groundwater table: 0.45 L/mm dia./100m length/hour
- Old system (25 years or older) and/or pipes below groundwater table: 1.0 L/mm dia./100 m length/hour

**3.7. Design Flow**

(a) Design flow Q (=PWWF) = population and equivalent x per capita flow x peaking factor + infiltration/inflow allowance.

**3.8. Pipe Flow Formulas**

**3.8.1. Gravity Sewers**

Use Manning’s formula:

$$Q = \frac{AR^{0.667}S^{0.5}}{n}$$

Where: Q = Design flow in m<sup>3</sup>/s

- A = Cross sectional area in m<sup>2</sup>
- R = Hydraulic radius (area/wetted perimeter) in m
- S = Slope of hydraulic grade line in m/m
- n = Roughness coefficient
  - Concrete = 0.013
  - PVC = 0.011

**3.8.2. Sewage Force Mains**

Use Hazen-Williams formula:

$$Q = \frac{CD^{2.63}S^{0.54}}{278780}$$

Where: Q = Rate of flow in L/s  
 D = Internal pipe dia. in mm  
 S = Slope of hydraulic grade line in m/m  
 C = Friction coefficient  
     → PVC = 130  
     → Ductile, Concrete Cylinder, Steel = 120

**3.9. Flow Velocities**

(a) Minimum design velocities:

- Gravity sewers: 0.60 m/s
- Force mains: 0.75 m/s

(b) Where steep grades result in velocities exceeding 6.0 m/s, consider measures to prevent pipe erosion and movement.

**3.10. Alignment**

(a) Except as noted in **3.13 – Curved Sewers**, horizontal and vertical alignments shall be straight lines between manholes for gravity sewers, and between defined deflection points for force mains.

(b) Force main line and grade requirements are as indicated for water mains. Air release valves are required at high points.

**3.11. Minimum Pipe Diameter**

**3.11.1. Gravity Mains**

(a) Minimum pipe diameters shall be:

- For residential lands – 200 mm; and
- For commercial and *industrial* – 250 mm.

(b) Terminal pipe section, upstream of the last intersection of mains, and where no further extension is planned, shall be:

- For residential lands – 150 mm at a minimum 1.0% grade; and
- For commercial and *industrial* – 200 mm at a minimum 0.60% grade.

**3.11.2. Forcemains**

(a) Minimum pipe diameter for forcemains shall be:

- 100 mm

### 3.12. Minimum Grades

#### 3.12.1. Gravity Mains

- (a) The grade of any sewer is governed by the minimum required velocity of 0.6 m/sec. If the calculated design flow is not expected to produce a velocity of at least 0.6 m/sec., then the minimum grade shall be calculated based on the pipe flowing 35% full at a theoretical velocity of 0.6 m/sec. However, the last section of a main that will not be extended in the future shall have a minimum grade of 1.0% where 150 mm diameter pipe is approved by the *Director*.

#### 3.12.2. Forcemains

- (a) Forcemains shall be graded at a minimum of 0.5%. Grading shall be designed to minimize high points. Provide air release valves at high points. The designer should consider specifying direct bury style air valves where possible to avoid using a valve chamber and having a confined space.
- (b) The material selected for force mains must meet the *District of Summerland* standards and must adapt to local conditions, such as character of *industrial* wastes, soil characteristics, exceptionally heavy external loadings, abrasion and similar problems.
- (c) All force mains must be designed to prevent damage from transient conditions.

### 3.13. Curved Sewers

- (a) Curved sewers may be permitted under special conditions where straight sewers and/or additional manholes are impractical. Where curved sewers are permitted by the *Director*, horizontal curves may be formed using pipe joint deflections as follows:
- Minimum radius = 60 m;
  - Constant radius throughout curve;
  - Joint deflection not to exceed 75% of maximum recommended by pipe manufacturer;
  - Minimum design velocity = 0.9 m/s;
  - Curve locations to be recorded at  $\frac{1}{4}$  points and midpoint; and
  - Constant offset from property line or Road centerline.
- (b) Where permitted by the *Director*, sewers larger than 600 mm diameter may include deflections formed by mitred bends, with minimum 1.25 m straight sections and maximum 45° mitres.

### 3.14. Depth

- (a) Depth shall be defined as the distance from the finished ground surface to the top of pipe.
- (b) Sewers shall be of sufficient depth to:
- Permit gravity sewer service to the basements of properties adjacent to the Roadway or sewer right-of-way;

- Prevent freezing;
- Meet the minimum depth requirements of 1.0 m in untraveled surfaces, otherwise 1.5 m cover;
- Clear other underground utilities;
- Prevent damage from surface loading; and
- Allow for future extension of the sanitary sewer system to service upstream tributary lands at ultimate Development, as defined by the Director.

(c) Minimum cover without concrete encasement: 1.0 m

(d) Maximum cover depth: 4.5 m, except under special circumstances and with permission of the *Director*.

### 3.15. Manholes

#### 3.15.1. Locations

(a) Manholes are required at:

- (i.) Every change in grade, except as permitted for curved sewers;
- (ii.) Every change in direction, except as permitted for curved sewers;
- (iii.) Every change in pipe size;
- (iv.) Downstream end of curved sewers;
- (v.) Every pipe intersection except for 100 mm and 150 mm service connections and junctions with trunk sewers 900 mm and larger;
- (vi.) 150 m maximum spacing;
- (vii.) Every future pipe intersection;
- (viii.) Upstream end of every sewer main;
- (ix.) Temporary clean-outs may be provided at terminal section of a main provided that:
  - Future extension of the main is proposed or anticipated.
  - The length of sewer to the downstream manhole does not exceed 45.0 m.
  - The depth of the pipe does not exceed 2.0 m at the terminal point
  - Clean-outs are not to be considered a permanent structure.
- (x.) Sanitary manhole rim elevations outside of paved *Roadways* shall be designed to be:
  - Above the adjacent storm manhole rim elevation
  - Above the surrounding ground so that infiltration from ponding will not occur
  - Above the 100 year return runoff event.

#### 3.15.2. Hydraulic Details

(a) Crown elevations of inlet sewers shall not be lower than crown elevation of outlet sewer.

(b) Minimum drop in invert elevations across manholes:

- Straight run: 5 mm drop;
- Deflections up to 45 degrees: 30 mm drop; and
- Deflections 45 to 90 degrees: 60 mm drop

- (c) Drop manhole and ramp structures shall be avoided where possible by steepening inlet sewers. Where necessary, provide drop structures as follows:

**Table 3.3 Drop Structures**

Invert Difference	Structure
Up to 0.25 m	Inside Ramp
0.25 to 0.90 m	Outside Ramp
Greater than 0.90 m	Outside Drop*

- (d) Inside drop may be used if specifically permitted by the *Director*.
- (e) The maximum deflection angle in a junction shall be 90°.
- (f) Force main discharges shall be directed into the receiving manhole outflow pipe. Manhole benching shall be extended a minimum 200 mm above the force main crown. If a manhole drop cannot be avoided, an inside drop pipe is required.

**3.16. Odour Criteria and Corrosion**

- (a) Dissolved sulphide maximum limit at any point in the system is to be 0.3 mg/l.
- (b) Odour Criteria:
- (i.) At 10 m from any gravity main, force main, manhole and lift station or other sewer facility (summer conditions, winds between 2-10 km/h), 1.0 odour units; and
  - (ii.) Where sewer facilities are close to houses, parks, or walkways, 0.0 odour units.
- (c) Odor control kept in outside building or kept inside a separate area in explosive rated area.
- (d) Analysis for odour and sulphides may be required.

**3.17. Service Connections**

- (a) Every legal *Lot* shall be provided with a separate service connection.
- (b) Unless otherwise permitted by the *Director*, connections are to serve all plumbing by gravity. Building elevations shall be established accordingly. Pumped connections may be permitted, if requested prior to sewer design, and if appropriate covenants are provided.

**3.17.1. Size**

- (a) Pipe size is to accommodate peak design flow. Minimum pipe diameter to be:
- Residential – 100 mm; and
  - Multi-family/commercial/institutional – 150 mm

**3.17.2. Location and Depth**

- (a) Connections to large *lots* are to be located at the lower portion of each *lot*.

- (b) For urban *developments*, locate connections in accordance with standard drawings.
- (c) Depth requirements are as indicated for sewer mains.
- (d) Service connections must be installed at the downstream corner of the *parcel* at an offset of 3.0 m from the property pin.
- (e) The minimum depth of a service at the property line must be 1.2 m within a *highway* right of way and 1.0 m within a statutory right of way.

### 3.17.3. Grade

- (a) Minimum grade from property line to sewer main.
  - 100 mm diameter pipe: 2.00%
  - 150 mm diameter pipe: 1.00%
  - Larger sizes: Grade based on minimum velocity of 0.75 m/s

### 3.17.4. Details

- (a) Use standard wye fittings for connections to new mains. For connections to existing mains, use wye saddles or, if approved, insertable tees. The service connection centreline must not be below the sewer main centreline.
- (b) Service connection may be permitted into manholes if:
  - The connection is not oriented against the flow in the main
  - Manhole hydraulic requirements are met
- (c) Control manholes are required on all *industrial* connections and on commercial connections where required by the *Director*.
- (d) Manholes are required on service connections larger than 150 mm diameter.
- (e) Connections exceeding 30 m in length will be treated as mains.

### 3.18. Locations and Corridors

- (a) Sewers should be located within *roadways* as shown on the applicable *MMCD* Standard Drawings. Servicing from *roadways* is required unless a depth greater than 4.5 m would be required to provide gravity service. Rear yard sewers and pumped connections are to be avoided, and advance approval is required.
- (b) Where a sewer crosses private land, right-of-way requirements are as indicated in Section 1.0, General Design Considerations.
- (c) Clearance from water mains is as indicated in Section 1.0, General Design Considerations.



**3.19. Lift Stations**

- (a) The use of lift stations shall be avoided where possible. Any proposed use of lift stations shall receive prior approval from the *Director*. Prior to commencing detailed design of a lift station, the *Consulting Engineer* shall submit a preliminary design report that addresses the design consideration of this bylaw. Approval of the preliminary design report shall be obtained prior to the *Consulting Engineer* commencing detailed design.

**3.19.1. Preliminary Design Requirements**

- (a) Lift station preliminary designs shall include:

System Layout:	Select location(s) to minimize long-term total number of pump stations.
Location:	Within right-of-way adjacent to <i>Road</i> .
Capacity:	Dependent upon the <i>Development</i> and catchment area.
	Designs must consider short, intermediate, and long-term future flows.
Configuration:	Above ground structure. Submersible duplex pump system unless otherwise approved in advance.
Materials:	As per <i>District of Summerland Approved Products List</i>

- (b) Other basic criteria include:

- (i.) *Construction* dewatering requirements;
- (ii.) Soils. Subsurface investigations must be undertaken prior to site approval;
- (iii.) Access for *construction* and maintenance;
- (iv.) Building structure to be concrete block. Aesthetics, noise, odour control and landscaping;
- (v.) Waterhammer and/or column separation prevention measures;
- (vi.) Security against vandalism and theft;
- (vii.) Flood elevations and station uplift design;
- (viii.) Proximity of receiving sewers, water mains, and power supply;
- (ix.) Minimizing energy requirements;
- (x.) Type of controls:
  - PLC or relays
  - Ultrasonic or float controls
  - SCADA connection or capability
  - Cellular phone service
  - One hour battery back up for control voltage
- (xi.) Standby power and 8 hours of emergency storage;
- (xii.) Sub-surface investigations must be undertaken prior to site approval;
- (xiii.) Convenience of operation and maintenance;
- (xiv.) Safety for operators and public;
- (xv.) Capital costs and operation and maintenance costs;
- (xvi.) Vehicle loads adjacent to and/or on station structure; and
- (xvii.) Davit and lifting arms for pumps and fall arrests.

**3.19.2. Design Features**

- (a) Lift stations shall be designed with a minimum of two pumps, capable of handling the maximum flow condition with any one pump offline. Where the design flow exceeds the capacity of a single, commonly available pump, use three or more pumps with capacities such that there is always one pump available for standby.
- (b) In general, a lift station will include the following main components: 1) Wet well structure including submersible pumps, 2) above ground Valve Kiosk and 3) a Controls Kiosk. Requirements for each of these components and related equipment are described in this Section.
- (c) Pump requirements:
- (i.) Capable of passing solids up to 75 mm in size.
  - (ii.) Maximum motor speed: 1750 RPM.
  - (iii.) Explosion proof—motor to be rated for CEC Zone 1, Class 1;
  - (iv.) 600 V 3-phase electrical power including VFD;
  - (v.) Easily removed for maintenance;
  - (vi.) Able to operate alternately and independently of each other;
  - (vii.) Able to meet maximum flow condition with one pump in failure mode; and
  - (viii.) Sized so that each motor does not cycle more than six times in one hour under normal operating conditions.
- (d) Swing check with outside lever and weight required on each pump discharge
- (e) Plug valves required outside pump station on influent line and each pump discharge line. Inlet valve to be direct buried and be operable from the ground surface. The pump discharge valves are to be located within the Valve Kiosk noted in Section 3.18.2.8. Minimum wet well size: 2.4 m diameter.
- (f) Wet well bottom to be benched to direct solids to pump suction.
- (g) Lift station hatches to be waterproof and provided with locks. Covers may be either stainless steel, aluminum or fiberglass. Minimum 900 mm x 900 mm in size. Fasteners to be 316 stainless steel. Lids to be 200 mm to 300 mm above ground level.

The access hatch shall have:

- An aluminum ¼" tread plate;
- A perimeter drain;
- A perimeter sealing gasket;
- A slam lock with an aluminum removable sealing plug and opening tool;
- A flush lift handle;
- A gas spring assist cylinder;
- A 90 degree hold open arm;
- A flush fitting padlock tang; and
- Hatch safety grate

The hatch shall be reinforced for 1,465 kg/m<sup>2</sup> (300 lbs/ft<sup>2</sup>) or withstand a loading of H-20 where subject to vehicular traffic. All fasteners to be made of 316 stainless steel.

- (h) Wet well to be equipped an above ground Valve Kiosk. The Valve Kiosk structure can be directly integrated into the wet well lid structure or be a standalone structure. The intent of the structure is to provide access to valving and instrumentation without having to enter a confined space. The check valve and isolation valve for each pump along with the station's flow meter, pressure transmitter (if applicable) and an air release valve are to be located within the kiosk. The Valve Kiosk must have 50 mm of insulation, 1000W intrinsically safe unit heater, door seals and a floor drain back to the wet well with p-trap and air relief ports piped to floor drain.
- (i) A removable multipurpose lifting arm shall be incorporated into the design of the pump station to facilitate the removal and installation of the pumps.
- (j) Access shall be located 0.6m above 200-year flood level or 1.0 m above highest recorded flood elevation.
- (k) Steel and fiberglass surfaces to receive minimum two coats of two-component white epoxy enamel. Concrete stations to be designed to prevent sulphide attack.
- (l) Auxiliary equipment and control panels to be housed in weatherproof Controls Kiosk adjacent to station. Kiosk to be located not less than 2.0 m and not more than 4.0 m from the station lid.
- (m) Controls Kiosk to contain a separate compartment for pump station ventilation fan.
- (n) Explosion-proof intake fan, activated by a manual switch, and of sufficient capacity to exchange the total volume of air inside the station with fresh air within 3 minutes. Fan to be in kiosk. Intake duct to terminate near maximum water level. Exhaust vent to be provided in top of pump station.
- (o) Wiring in station and fan compartment to be explosion-proof, Class 1, Division 1. Electrical design and installation subject to approval by Provincial Safety Inspector.
- (p) Explosion proof switched receptacle and plugs not in wet well. Receptacles to be mounted near wet well for easy access by operator, and to accommodate power cables for pump controls.
- (q) Levels to be controlled by ultrasonic level transmitter, plus emergency high- and low-level floats.
- (r) Control panel to include hour meter and ammeter for each pump.
- (s) 120 V outlet for hand tools.
- (t) The lift station shall include a PLC based control system, instrumentation, SCADA telemetry in accordance with *District* standards, including:
  - (i.) Feedback signals from and control signals to each motor starter;
  - (ii.) Lead pump selection, including the option to alternate;
  - (iii.) VFDs or electronic soft starters, with ramping, to minimize starting and stopping surges

- (iv.) Continuous level monitoring for pump control;
  - (v.) Emergency high and lowlevel switches for back up control, independent of the PLC control system;
  - (vi.) Magnetic flow meter, with flood monitoring in flow meter chamber;
  - (vii.) Flood monitoring in valve chamber;
  - (viii.) Kiosk temperature monitoring;
  - (ix.) Power supply status from the automatic transfer switch;
  - (x.) Running and fault feedback signals from the standby generator;
  - (xi.) HMI for local monitoring; and
  - (xii.) UPS power supply.
- (u) Control kiosk to be designed to contain control and SCADA equipment and dialer on front panel and power equipment on rear panel. Concrete base to be minimum 75 mm above finished grade.
- (v) Pump stations to include automatic generator sets for standby power in case of power failure. Provision for SCADA system to be included. Generator set enclosures to be weatherproof and to include noise control. For small pump stations, emergency storage may be considered in place of standby power. Emergency storage is to be based on 8 hours of average *Day* flows plus infiltration.
- (w) Noise levels for facilities must not exceed 65 dB at property line or 20 m away whichever is closer.
- (x) A 50 mm diameter water connection with standpipe and cross-connection protection must be provided on-site for cleaning purposes.
- (y) Provide for standby pumping from an external source. An adaptor flange (“Camlock”) complete with a quick coupling and lockable cap shall be required.
- (z) Area around station and related equipment or building is to be graded, asphalted, and fenced. Size of area to be determined by maintenance requirements with a minimum 1.2m clearance to structures with doors opened. Layout of structures and gates is to provide for clearances for pump removal by hoist truck. Location and access to be approved by *Director*.
- (aa) Odour control per Section 3.16.
- (bb) Design in accordance with appropriate seismic standards.
- (cc) Equipment to be CSA approved and have minimum one-year guarantee on parts and labour. All equipment must be tested prior to acceptance.
- (dd) Designer to provide a commissioning plan include operator training (amount to be determined by the scale of the facility) and schedule.
- (ee) Provide three copies of a comprehensive Operating and Maintenance Manual, in hardback bound format with name of facility embossed on cover. Manuals shall contain a table of contents

with each section identified by a plasticized, labeled divider. The manual must contain an operation and control narrative.

### 3.20. Low Pressure Sewers

- (a) In areas beyond the reach of the community gravity sewer system and not large enough to provide economic justification for a community pump station, or where soil conditions or topography are not suitable for gravity sewers, the *Director* may consider approval of a low-pressure sewer system, which involves private pump units discharging into a public low pressure sewage force main. The *Consulting Engineer* must review the design concept and proposed guidelines with the *Director* and obtain approval before proceeding with design.

<b>4. Stormwater Management</b> .....	<b>37</b>
4.1. General .....	37
4.2. Design Overview .....	38
4.3. Runoff Analysis .....	40
4.4. Site Design .....	45
4.5. Minor System .....	46
4.6. Major System .....	57
4.7. Detention Facilities .....	61
4.8. Sediment and Erosion Control .....	64
4.9. Stormwater Quality .....	67
4.10. Pumping Systems .....	71
4.11. Hillside Standards .....	71

**4. Stormwater Management**

**4.1. General**

**4.1.1. Overview**

- (a) The purpose of this stormwater management section is to standardize the procedures for designing common drainage facilities in the *District of Summerland*. All drainage works will be designed with considerations for public safety, regulatory requirements, and the natural environment. The *Owner* will consult with the *Director* to determine what existing information may be of assistance to them.
- (b) The presence of an existing municipal drainage system does not mean, or imply, that the system has adequate capacity to receive the proposed design flows, nor does it indicate that the existing system pattern is acceptable to the *District of Summerland*. Existing facilities that are undersized or inadequate to accept additional drainage must be upgraded at the *Owner's* expense to accommodate the appropriate flows. Alternative drainage proposals may be considered.
- (c) Stormwater management designs must conform to local government bylaws, regulations, and policies plus federal and provincial statutes and guidelines. These include, but are not limited to, the following:
  - The District of Summerland Stormwater Management Design Guidelines
  - Existing Master Drainage Plans, Watershed Plans, or Integrated Stormwater Management Plans
  - Local Government Act
  - Fisheries Act
  - Water Sustainability Act
  - Canadian Navigable Waters Act
  - Canada Wildlife Act
  - Migratory Birds Convention Act
  - Dike Maintenance Act
  - Land Development Guidelines for the Protection of Aquatic Habitat (Canada/B.C.)
  - National Guide to Sustainable Municipal Infrastructure (Canada)

- Best Practices for Protection of Groundwater Resources in British Columbia (BC)
- Standards and Best Practices for Instream Works (Canada/BC)
- Riparian Areas Protection Regulation (BC)
- Canadian Dam Association Dam Safety Guidelines
- Applicable Professional Practice Guidelines provided by Engineers and Geoscientist British Columbia
- MMCD Green Design Guideline Manual

(d) Where there is a discrepancy between this Schedule and any of the above-referenced documents, the more stringent requirements or guideline shall govern. Also note that the design standards in this Schedule are to be considered a minimum expectation.

#### 4.1.2. Storm Drainage System Triggers

- (a) If a storm drainage system is required pursuant to this Bylaw, the *Owner* of the *parcel* being *subdivided* or developed must provide the proposed *subdivision* or the *parcel* being developed with a storm drainage system *constructed* and installed in accordance with the provisions of this Bylaw.
- (b) In addition to the requirements of **Schedule C**, a storm drainage system is required where the *subdivision* or *development* is located in an area where drainage studies prepared for the *District* and adopted by the *Council* indicate that drainage work should be *constructed*.

#### 4.1.3. Georeferenced Data

- (a) It is the *Consulting Engineer's* responsibility to ensure that they obtain true and accurate elevations for the *development* of the site and to confirm the accuracy of any mapping or information that may be provided by the *District*.

### 4.2. Design Overview

#### 4.2.1. General Requirements

- (a) The *Consulting Engineer* must design the storm drainage system so that all downstream drainage facilities are capable of handling the determined, controlled post *development* flows.
- (b) All stormwater runoff that is discharged to a receiving water, whether directly or indirectly, must be treated using approved methods and to an approved standard.
- (c) A Stormwater Management Plan must be prepared and approved for all phases of the proposed *development* to ensure required drainage routes and facilities are adequately identified, protected, and sized for ultimate *development* conditions. The level of detail required is contingent on the size and type of *development* proposed.

#### 4.2.2. Dual Drainage System

Each storm drainage system must consist of a minor and a major drainage system as defined below:

**4.2.2.1. Minor Drainage System**

The minor drainage system is comprised of storm sewers, swales, channels, culverts, and flow control facilities designed to prevent flooding and property damage, and to minimize public inconvenience caused by frequent storm events. Runoff from the minor storm is referred to as the Minor Flow.

**4.2.2.2. Major Drainage System**

The major drainage system comprises surface flood paths, drainage outlets (i.e. designated storm sewers that convey the major flow), ditches, *roadways*, *watercourses* and flow control facilities designed to accommodate the runoff from rare and intense storms. It shall be designed to protect the public and prevent significant property damage due to flooding caused by these rare and significant storm events. Runoff from these storm events is referred to as the Major Flow.

**4.2.3. Service Levels**

- (a) The service level for each of the drainage systems is defined by the capacity required to convey or control runoff from design storm events with return periods specified in Table 4.1.

**Table 4.1 System Service Level Return Periods**

Drainage System	Design Return Period
Minor	10 years
Major	100 years
Culverts & Bridges on Streams	200 years

**4.2.4. Control Criteria**

- (a) Stormwater discharge generated by the *subdivision* or *development* shall be controlled to reduce downstream impacts and to mimic the *pre-development* conditions as much as possible. The following level of runoff control shall be provided:

**Table 4.2 Control Criteria**

Control Objective	Criteria
Water Quality Control	Treat 70% of the 2-year/24-hour <i>post-development</i> runoff volume or 90% of the average annual <i>post-development</i> runoff volume, depending on whether the design is based on single-event analysis or continuous simulation.
Runoff Rate Reduction	Store runoff from the critical minor-system design rainfall event and release it at a rate that approximates the natural <i>pre-development</i> Minor Flow.
Peak Flow Conveyance	Ensure that the Major Drainage system is able to safely convey <i>post-development</i> runoff from extreme storm events (up to and including the Major Flow) with little or no damage to public and private property. If this is not



	feasible, then Control Criteria for discharge to the Major System shall be as specified by the <i>Director</i> .
--	--

- (b) Offsite discharge rates not based on the above criteria may be allowed at the discretion of the *Director* based on downstream system capacity and/or ability to convey flows without causing erosion, negative impacts to the Receiving Water, flooding, damage to flood protection works, or degraded water quality.

**4.3. Runoff Analysis**

**4.3.1. General**

- (a) This section describes the rationale, methodology, and parameters for determining the design runoff rates and volumes corresponding to the proposed *Development* or *Subdivision*. This includes runoff generated within catchments both tributary to and within the *Development* or *Subdivision*. Where analysis of downstream conveyance systems by the *Owner* is required, runoff rates and volumes from catchments tributary to these works shall also be determined.

**4.3.2. Upstream Catchments**

- (a) The Design shall be sized to safely convey runoff from upstream catchments tributary to the *Development* or *Subdivision*. Design runoff values from upstream catchments shall be determined in consultation with the *Director* to reflect anticipated future land uses within these drainage catchments.

**4.3.3. Pre-Development Runoff**

- (a) In general, and for the purposes of this Schedule, “pre-development” refers to natural land cover prior to any disturbances or alterations by humans – including *roads*, clearings, agriculture, and buildings. The pre-development flow shall be calculated using:

$$Q_T = A \times URR_T$$

Where:  $Q_T$  = pre-development runoff rate for a specified return period “T”, m<sup>3</sup>/s

A = drainage area, hectares

$URR_T$  = Unit Runoff Rate for the return period “T”, Lps/ha, as found in the *District’s* Stormwater Management Design Guidelines

- (b) Alternatively, pre-development runoff may be determined using the Hydrograph Method. In this case, the model must reasonably reflect field hydrology conditions based on flow measurements and/or reliable anecdotal evidence. Modeling results are subject to approval by the *Director*.

**4.3.4. Climate Change**

- (a) To account for a changing climate, the rainfall IDF values presented in *District's* Stormwater Management Design Guidelines have been adjusted to reflect projected rainfall intensities to the year 2100. This accommodation is adequate for single-event design storms. However, should continuous modelling be required, appropriate continuous climate values projected to 2100 must be used. These continuous data sets shall be obtained from the *District*.

**4.3.5. Acceptable Methods**

Storm drainage design shall be carried out using one or both of the following methods.

**4.3.5.1. Rational Method**

The Rational Method is applicable for preliminary design and for detailed design of minor drainage systems in urban areas, and for the purposes of computing peak flow rates where no retention or detention features are included. Use of the Rational Method shall be limited to hydrologically simple and uniform catchments with a combined area less than 10 hectares. Its application shall also be limited to sizing conveyance systems only. It shall not be used to establish *pre-development* hydrology.

**4.3.5.2. Hydrograph Method**

Computer models that generate hydrographs shall be used for hydrologic and hydraulic analysis for all instances where the combined drainage catchment area is larger than 10 hectares, where drainage catchments are hydrologically complex, and/or where stormwater management systems require more than basic conveyance (systems include green infrastructure, detention or retention storage, infiltration systems, and/or pump stations for example). This method is also acceptable for *developing pre-development* runoff rates provided that the model adequately reflects anecdotal or recorded flows using historical rainfall events.

**4.3.5.3. Continuous Simulation**

A continuous simulation model shall be used to design infrastructure where system capacity is based on runoff volumes that must be stored and/or released over extended time periods. Climate data time series may have a duration as short as several days (multi-day storms) or as long as several years or decades – the duration required shall be determined by the *Director*. The maximum time interval for the rainfall time series shall be 1 hour. Digital files of hourly rainfall and temperature data can be obtained from the *District*.

**4.3.6. Rational Method**

**4.3.6.1. Formula**

The Rational Formula is expressed as:

**Equation 4-1**

$$Q = CIA/360$$

Where:  $Q_T$  = peak runoff for a specified return period "T",  $m^3/s$

C = runoff coefficient

A = drainage area, hectares

$I_T$  = rainfall intensity for the return period "T" and storm duration equal to the Time-of-Concentration ( $T_c$ ), mm/hr

**4.3.7. Runoff Coefficients**

- (a) Runoff Coefficient (C) values shall be established based on the proposed land uses, proposed **developments**, soils, catchment slopes, and hydrogeological information. Calculations and rationale for the C values selected shall accompany **development** submissions.
- (b) “Default” C values, as shown on Table 4.3 may also be used.

**Table 4.3 Rational Method Design Runoff Coefficients**

Land Use	Minor Storm	Major Storm
Commercial	0.85	0.90
Industrial	0.75	0.80
Institutional	1	1
Residential - Single-Family areas	0.40	0.50
Residential - Multi-units, detached	0.50	0.60
Residential - Multi-units, attached	0.60	0.70
Apartments	0.75	0.80
Parks / Cemeteries	0.20	0.25
Streets – Asphaltic	0.85	0.95
Streets – Concrete	0.85	0.95
Drives and Walks	0.80	0.90
Roofs	0.80	0.90
Green Space (Lawn)	0.15	0.20
Landscaped (Trees / Shrubs)	0.10	0.15
Orchards / Vineyards (Mature)	0.12	0.18
Natural Areas <sup>2</sup>		
Slope < 2%	0.04	0.09
3% < Slope < 6%	0.09	0.14
Slope > 6%	0.13	0.18

<sup>1</sup> Calculate weighted average value based on site land use composition as per Equation 4-2.

<sup>2</sup> Adjust to reflect amount, type, and density of vegetation - subject to approval by *Director*.

Note: The above table assumes conventional site drainage of directing all surface drainage overland into streets and catch basins. The runoff coefficients account for “wet” antecedent conditions.

- (c) In a case of applying the Rational Method to a mixed land use in a drainage area, a weighted average C value shall be used and can be calculated from the following equation:

**Equation 4-2**

$$C_{avg} = \frac{\sum A_i C_i}{A}$$

Where:  $C_{avg}$  = the average runoff coefficient for the catchment  
 $A_i$  = the area of land within the catchment correlated to runoff coefficient  $C_i$ , and  
 $A$  = the total catchment area

**4.3.8. Time-of-Concentration**

- (a) The value of the design rainfall intensity ( $I_T$ ) for the Rational Method is selected from the appropriate Intensity Duration Frequency (IDF) curve, with a duration chosen to coincide with the Time-of-Concentration ( $T_C$ ).  $T_C$  is the time required for run-off to become established and reach the catchment outlet from the furthest point within the contributing drainage catchment.  $T_C$  is the sum of two components, the “inlet time” and the “travel time”.

**4.3.9. Inlet Time**

- (a) The inlet time is the time it takes for overland flow to enter the conveyance system. It varies with size of the catchment area and surface imperviousness. In developed urban areas where paved surfaces drain directly to catch basins, the inlet times provided in Table 4.4 shall be used. The minimum inlet times reflect roof leaders and parking *lot* drainage (hard surface) being discharged directly into a piped storm system. The maximum inlet times reflect roof leaders and parking *lot* drainage being discharged onto ground (grass, gravel, swales) and accounting for travel distances and other variables. It is the *Consulting Engineer’s* responsibility to verify that the selected values are appropriate and provide recommendations to the *Director* for approval where variations are appropriate.

**Table 4.4 Inlet Times for TC Calculations**

Lot Type	Minimum Inlet time	
	10-Year	100-Year
Single Family Residential	15	10
Multi Family Residential	10	5
Commercial/Industrial/Institutional	10	5

- (b) For inlet times in *rural* areas, the overland flow time must be calculated using one of the following methodologies.

**4.3.9.1. Travel Time**

- (a) The travel time is the length of time required for flow to travel within the conveyance system from the point of inflow to the location being analyzed – typically the catchment or system outfall. When the channel or pipe characteristics and geometry are known, the preferred method of estimating channel flow time is to divide the travel length by the average travel velocity obtained by using the Manning equation. This may require one or two iterations since the flow rate used to calculate the velocity must first be estimated, then calculated using the results based on the initial assumption. Default roughness coefficients for different types of open channel linings and pipe materials are found in Table 4.7 and Sections 4.5.2 and 4.5.8.3.

**4.3.9.2. Developed Areas – Use FAA Airport Equation**

- (a) Common time of concentration calculations include the FAA, Kirpich, and Kerby equations. The FAA (U.S. Federal Aviation Administration) equation is the most commonly used of the three because it uses the widely recognized Rational Coefficient to describe watershed ground cover.

**Equation 4-3**

$$T_c = 3.26 (1.1 - C) L^{0.5} / (S)^{1/3}$$

Where:  $T_c$  = Time of concentration (minutes)  
 $C$  = Rational method runoff coefficient  
 $L$  = Longest *watercourse* length in the watershed (m)  
 $S$  = Average slope of the *watercourse* (m/m)

**4.3.9.3. Rural / Undeveloped Areas – Use BC Water Management Method**

- (b) This method was developed by the BC Ministry of Environment, Water Management Division, Hydrology Section. It is limited to drainage areas up to 1000 ha and is dependent on the catchment’s characteristics. Equation 4-4 and corresponding coefficients in Table 4.5 reflects curves fitted to the graphical method presented in the BC Supplement to TAC Geometric Design Guide.

**Equation 4-4**

$$T_c = aA + bA^{0.5} + c$$

Where:  $T_c$  = Time of concentration (hours)  
 $A$  = Catchment area (ha)

**Table 4.5 Water Management Method Coefficients**

Catchment Slope	Coefficients		
	a	b	c
Flat (slope ≈ 0%)	-0.0416	4.5609	0.4984
Rolling (slope ≈ 1%)	0.0488	3.0973	0.3041
Moderate (slope ≈ 2.5% slope)	-0.0113	2.2271	0.0642
Steep (slope > 10%)	0.0233	0.9075	0.0832

- (c) Note that for agricultural and *rural* basins, the curves labeled Flat or Rolling should be used. For forested watersheds, the curves labeled Rolling, Moderate, or Steep should be used.

**4.3.10. Rainfall Intensity**

- (a) Rainfall intensities shall be determined from the IDF data presented in the most recent version of the *District’s* Stormwater Management Design Guidelines. Values obtained from the Guidelines shall be included in the *Consulting Engineer’s* Design Brief accompanying the SWM Plan.

**4.3.11. Hydrograph Method**

**4.3.11.1. General**

- (a) Analysis using the Hydrograph Method requires computer software capable of modelling the hydrologic characteristics of the watershed and generating runoff hydrographs from rainfall hyetographs. The hydrographs are typically routed through a network of open channels, conduits, storage facilities, and other stormwater management infrastructure or components.

Hydrographs may be generated from single-event storms as well as from continuous time series covering multiple rainfall events or even years-worth of historical rainfall and climate data. The Hydrograph Method shall be used to analyze non-homogeneous drainage catchments, complex combinations of infrastructure and runoff controls, and/or the effects of timing due to flow routing through the system. Analyses and reporting shall be completed as per the *District's* Stormwater Management Design Guidelines.

## 4.4. Site Design

### 4.4.1. Site and Lot Grading

- (a) A comprehensive *lot* grading plan shall be prepared by the *Consulting Engineer*. The plan shall retain as many natural surface drainage features as possible while meeting the grading requirements of all the proposed *lots* within the *Development* area. The grading plan shall also mitigate or at least minimize impacts on existing adjacent *Development* areas.
- (b) Grading shall comply with the B.C. Building Code and be prepared as per the *District's* Stormwater Management Design Guidelines.

### 4.4.2. Driveway Rough-in

- (a) Driveways for *lots* fronting a *road* serviced by a *rural road* section (ditches and culverts) shall be roughed-in at the direction of the *Director*. This shall include a driveway culvert, sized and installed as per Section 4.5.8 of this Schedule.

### 4.4.3. Minimum Building Elevation (MBE)

- (a) The MBE applies to the elevation of the lowest floor slab in a building or the underside of the floor joists where the lowest floor is *constructed* over a crawl space. Crawl space is defined as the space between a floor and the underlying ground having a maximum height of 1.2 m to the underside of the joists and is not used for the storage of goods or equipment damageable by flood waters.
- (b) The MBE shall be at least 0.60 m above the storm sewer service connection invert and 0.30 m above the Major Drainage System hydraulic grade line (HGL), whichever requires the greater MBE. Establishment of the MBE shall also consider the influence of the groundwater table at its annual peak.
- (c) For sites near a *watercourse* for which a floodplain elevation has been established, the MBE shall be a minimum of 0.30 m above the instantaneous 200-year return period flood elevation or 0.60 m above the maximum daily 200-year return period flood elevation. Where a flood elevation has not been established, setbacks should be as per current Provincial guidelines. Where more than one setback is applicable, the greater distance shall be applied.

## 4.5. Minor System

### 4.5.1. Service Level

- (a) The Minor System is considered as a “convenience” system. It is intended to capture and convey runoff from frequent rainfall and typical snowmelt events. For *roads* with an urban cross section, the minor system may include curbs, gutters, catch-basin inlets, catch-basins, catch-basin leads, manholes, storm sewers, flow-control structures, detention storage, infiltration systems, stormwater quality treatment, and outfalls. For *roads* with *rural* cross sections, the Minor System may include ditches, culverts, and vegetated swales. The Minor System may also include green infrastructure and Low Impact Development (LID) Best Management Practices (BMPs).

### 4.5.2. Storm Mains

#### 4.5.2.1. Sizing

- (a) Storm sewers shall be designed as open channels sized to provide the required capacity in free flow (not surcharged) conditions using Manning's formula. The following Manning's roughness coefficients shall be used:
- 0.011 for smooth-walled PVC or HDPE pipes
  - 0.013 for smooth-walled concrete pipes
  - 0.024 for corrugated metal pipes
- (b) The minimum storm sewer diameter shall be:
- 250 mm for mains within all residential/single family zones
  - 300mm for mains within all industrial/commercial/multi-family zones
- (c) Downstream pipe sizes shall not to be reduced unless the downstream pipe is 600 mm diameter or larger and increased grade provides adequate hydraulic capacity without exceeding velocity limits. Detailed hydraulic analysis and the *Director* approval is required. The maximum reduction is two pipe sizes.
- (d) Storm sewers may be sized according to the required capacity taking 50% of the capacity of any upstream infiltration facilities into consideration. The infiltration capacity must be calculated and justified by a Qualified Professional experienced in this field. In no case shall main diameters be less than the specified minimums.

#### 4.5.2.2. Surcharged Storm Sewers

- (a) Surcharged sewers to convey the design flows are permitted only as exceptions and with completion of a report by the *Consulting Engineer* and approval of the *Director*. In all such cases, it must be clearly demonstrated that the projected highest hydraulic grade line has no impact on downstream properties.

**4.5.2.3. Grades and Velocities**

- (a) Minimum grades of storm mains, flowing full or half-full, are required to obtain the minimum velocity of 0.6 m/s. Where velocity exceeds 4.5 m/s, or when super-critical flow occurs on steeper slopes, flow throttling or energy dissipation measures to prevent scour or to accommodate the transition back to subcritical flow may be required. Where the slope of the storm sewer main exceeds 10%, but is less than 20%, anchorage shall be considered by the *Consulting Engineer*.
- (b) Where slope is 20% or greater, anchorage must be incorporated into the design. Anchorage must be *constructed* in accordance with Standard Drawings. At the discretion of the *Director*, the *Consulting Engineer* shall also determine if special provisions are required to protect against displacement of sewers by erosion or shock. These provisions shall be incorporated into the design and adequately detailed in the *design drawings* and specifications.

**4.5.2.4. Discharge to Natural Watercourses**

- (a) Runoff from *developments* near Okanagan Lake may be discharged directly to the lake provided that the required minor and major systems exist, stormwater quality is addressed, and approval from the appropriate provincial authority is obtained. *Developments* within the remaining areas of the *District* are required to attenuate offsite discharge to the appropriate *pre-development* runoff rate via on-site controls.
- (b) Where drainage discharge enters a natural *watercourse*, maximum discharge velocities shall be less than 1.0 m/s. All proposals for works affecting natural *watercourses* must be forwarded by the *Owner* to the appropriate provincial and/or federal authorities for review and approval. Should siltation or erosion controls be required by the above agencies, details of the proposed works must be included in the engineering drawings and must be installed as part of the works.

**4.5.2.5. Public ROWs**

- (a) Storm sewers shall be located as shown on the Standard Drawings within a *Subdivision road* right-of-way (ROW) or open *lane*. Where this is technically impractical, and it is proposed to place storm sewers within private property, the *Consulting Engineer* shall provide rationale and analysis for approval by the *Director*. All works to be owned by the *District* shall be located within a Statutory Right of Way (SROW).

**4.5.2.6. Statutory ROW Through Private Land**

- (a) When a stormwater management works are located within a statutory right-of-way (SROW) across private land, and appurtenances which require maintenance are located within the right-of-way, the *Property Owner* must ensure that maintenance access is available. For large structures or structures requiring an enhanced maintenance level such as oil/sediment chambers, control structures, and pond inlet/outlet chambers, an access route adequate to support the maintenance vehicles shall be provided. The surface of the route may be gravel, concrete pavers, or asphalt depending on the location and the context of the site at the discretion of the *Director*.



- (b) SROW requirements are further defined in the section on Utility Rights-Of-Way under the General Design Considerations section of this bylaw.

#### 4.5.2.7. Depth and Cover

- (a) Storm sewers should be of sufficient depth to:
- Permit gravity service to all tributary areas, including both sides of the roadway if feasible,
  - Prevent freezing,
  - Clear other underground utilities, and
  - Prevent damage from surface loading.
- (b) Storm sewers shall be designed with cover ranging from a minimum of 1.2 m to a maximum of 4.5 m above the crown of the pipe, subject to approval by the *Director*.

#### 4.5.2.8. Alignment

- (c) Except as indicated for Curved Sewers, horizontal and vertical alignments shall be straight lines between manholes unless approved by the *Director*.

#### 4.5.2.9. Curved Storm Sewers

- (a) Where permitted by the *Director*, horizontal and vertical curves may be formed using pipe joint deflections as follows:
- Minimum radius shall be 300 times the outside diameter of the pipe barrel (300 x D) or 1.5 times the manufacturer's recommended minimum radius of curvature – whichever is greater.
  - Constant radius throughout curve.
  - Joint deflection not to exceed 50% of maximum recommended by pipe manufacturer.
  - Minimum design velocity = 0.9 m/s.
  - Minimum grade = 1.0% (0.01 m/m).
- (b) The curve midpoint and two quarter-points shall be located by survey and shown on the *as-constructed* drawings with corresponding invert elevations and offsets.
- (c) Subject to local *Director* approval, sewers larger than 600 mm diameter may include deflections formed by mitred bends to a maximum mitre of 45 degrees.

#### 4.5.2.10. Ditch Inlets

- (a) The minimum pipe diameter for ditch inlets to the storm sewer system shall be 400 mm. All ditch inlets shall be connected to a manhole. All ditch inlets to storm sewers shall be equipped with a headwall, and for large pipes (>600 mm diameter), debris screens. If directed by the *Director* the ditch inlet shall include a sedimentation basin or trap.

#### 4.5.2.11. Temporary Cleanouts

- (a) Temporary clean-outs may be provided at terminal sections of a main provided that:
- Future extension of the main is proposed or anticipated,

- The length of storm drain to the downstream manhole does not exceed 45.0 m, and
- The depth of the pipe does not exceed 2.0 m at the terminal point.

#### **4.5.2.12. Pipe Joints**

- (a) Watertight joints are preferred, but open joints may be used subject to approval by the *Director* to support groundwater recharge. However, since open joints can increase the risk of erosion within pipe bedding, their use shall be limited to grades less than 5%. Where the use of open joints is approved, gravel rather than sand bedding shall be used.

#### **4.5.2.13. Continuous Directional-Drilled Pipe**

- (a) Continuous piping that is installed using directional-drilling techniques shall be installed as per **Schedule D, SS 33 11 02 – Horizontal Directional Drilling**.

### **4.5.3. Manholes**

#### **4.5.3.1. Where Required**

- (a) Manholes are required at the following locations:
- Every change of pipe size.
  - Every change in grade, except as indicated for curved sewers.
  - Every change in direction, except as indicated for curved sewers.
  - Upstream end of every sewer line.
  - Downstream end of curved sewers.
  - Every pipe and service connection intersection as per Standard Drawings.
  - Every catch basin connection.
  - Outfalls to the major system (i.e. creeks, channels, lake) in order to isolate the upstream main to facilitate cleaning. The manhole shall be located as close as possible to the point of discharge.

#### **4.5.3.2. Spacing**

- (a) The maximum distance between manholes shall be:
- 150 m for pipes with diameters less than 900 mm, or
  - 250 m for pipes with diameters 900 mm and larger.

#### **4.5.3.3. Hydraulic Considerations**

- (a) The crown of the downstream pipe must not be higher than the crown elevation(s) of the upstream pipe(s).
- (b) Minimum drop in invert elevations across manholes:
- Straight runs: 5 mm drop
  - Deflection up to 45 degrees: 20 mm drop
  - Deflection 45 to 90 degrees: 50 mm drop

**4.5.3.4. Hydraulic Losses**

- (a) Hydraulic losses shall be calculated for manholes with significant change of grade or alignment. For high velocity flows, particularly for pipes with diameters 600 mm or larger, detailed analysis using the Froude number, or utilizing appropriate computer models is required. The Manning’s equation should not be relied on for pipe slopes above 10%. For low to moderate velocities and smaller pipes, use following equation:

**Equation 4-5**

$$H_L = k V^2 / 2g$$

Where:  $H_L$  = head loss (m)  
 $V$  = flow velocity entering junction (m/s)  
 $g$  = gravitational acceleration (9.81 m/s<sup>2</sup>)  
 $k$  = head loss coefficient (1.0 for channelled 90 degree bends and tees to 1.5 without channelized benching)

- (b) Where benching is used, the minimum drops listed in Table 4.6 are applicable for velocities below 1 m/s. Where flows exceed 1 m/s,  $H_L$  should be specifically computed - the greater of the two values shall be used as the drop across the junction.

**4.5.3.5. Drop Manholes**

- (c) Drop manholes and outside ramp structures should be avoided where possible by steepening inlet sewers. Where necessary, drop manholes or outside ramps shall be installed as follows:

**Table 4.6**

Invert Difference	Structure
Up to 0.25 m	Inside Ramp
0.25 to 0.90 m	Outside Ramp
Greater than 0.90 m	Outside Drop*

\* Inside ramps may be permitted, but only where the proposed alignment conflicts with existing utilities or where an inside ramp is required to match upstream and downstream pipe slopes. Inside ramps must not exceed 450 mm and must be approved by the *Director*.

**4.5.3.6. Lid Markings**

- (a) All manhole lids shall be clearly labelled “Storm Sewer”.

**4.5.4. Catch Basins**

**4.5.4.1. General**

- (a) Catch basins are required at regular intervals along *roadways*, at intersections, and at low points.

- (b) Side-inlet catch basins are required for all curbed *roads*. Lawn basins are required on boulevards and private properties where necessary to prevent ponding or flooding of sidewalks, boulevards, driveways, buildings, and yards.
- (c) Catch basin grates shall be installed as specified in the *District's* Standard Drawings. Alternate grates may be allowed providing that corresponding rating curves are submitted to and approved by the *Director*.
- (d) All catch basins shall discharge to a storm sewer system or approved infiltration system. Direct discharge from catch basins to natural streams or receiving waters shall not be allowed.

#### 4.5.4.2. Spacing

- (a) Catch basin spacing shall provide sufficient inlet capacity to collect the entire minor flow, or major flow if required, into the pipe system. To ensure that the capture or inlet capacity matches the storm main capacity, the spacing of catch basins on streets shall, at the minimum, meet the following criteria:
  - (i.) *Road* grades less than or equal to 3%: maximum spacing of 150 m or 675 m<sup>2</sup> of paved area, whichever is more stringent.
  - (ii.) *Road* grades greater than 3%: maximum spacing of 100 m or 450 m<sup>2</sup> of total area.
  - (iii.) Space catch basins to ensure no overflows to driveways, boulevards, sidewalks, or private property.
  - (iv.) Space catch basins at intersections so as not to interfere with crosswalks.
- (b) The *Consulting Engineer* shall provide confirmation that the above-listed maximums have not been exceeded by the design.

#### 4.5.4.3. At Low Point

- (a) Double, side-inlet catch basins are required at all low points on a *road*, including *cul-de-sacs*. The double CBs are required on both sides of the *road* if it is crowned, and only on the lower side of the *road* if it is cross-falled or super-elevated.

#### 4.5.4.4. Sediment Trap

- (a) All catch basins shall be equipped with a sump to capture and hold sediment as specified in Summerland Standard Drawings.

#### 4.5.4.5. CB Lead Minimum Diameters

- (a) All catch basin leads shall be sized to convey the design inlet capacity, subject to the following minimum diameters:
  - from single, top-inlet catch basin – 200 mm
  - from double top-inlet or side-inlet catch basins – 250 mm

#### 4.5.4.6. Minimum Slope

- (a) The minimum slope of the lead shall be 2.0% unless otherwise specified by the *Director*.

#### 4.5.4.7. Connections

- (a) All catch basin leads shall discharge into a manhole.

#### 4.5.4.8. Cover

- (a) Catch basin leads shall have a minimum cover of 0.9 m. If this is not feasible, the design shall include traffic load and frost protection. Design calculations must be provided.

### 4.5.5. Service Connections

#### 4.5.5.1. General

- (a) Every legal *lot* and each unit of a residential duplex shall be provided with a separate service connection where disposal to ground of discharge from foundation perimeter drains and/or roof drains is not recommended by a Qualified Professional. Connections shall drain away from building foundations by gravity, but pumped connections may be permitted if requested prior to design, approved by the *Director*, and appropriate covenants are provided.

#### 4.5.5.2. Foundation Drains

- (a) Foundation perimeter drains for buildings are required as per the British Columbia Building Code. Where the hydrogeological study justifies their use, dry wells or ground infiltration systems may be used as the storm water disposal method for connection of perimeter drains. These systems shall be designed and supervised by a Qualified Professional.
- (b) Foundation perimeter drains are not permitted to be directed to any infiltration device or soak away pit that impacts an engineered retaining wall or reinforced earth structure.
- (c) Where infiltration systems are not recommended in the hydrogeological study, foundation perimeter drains may be connected by gravity via a storm service to the storm main provided that:
  - (i.) the elevation of the basement/crawlspace floor is at least 600 mm above the elevation of the storm main obvert, or
  - (ii.) 600 mm above the anticipated or known high ground water table, or
  - (iii.) 600 mm above the 100 year hydraulic grade line within the main at that point, whichever is higher.

#### 4.5.5.3. Roof Leaders

- (a) Roof drainage leaders may be connected to the storm service connection only where geotechnical requirements dictate the need, otherwise, roof leaders shall be directed to a splash pad for dispersal to the ground. The evaluation of this requirement shall be included in the scope of the Hydrogeological Study.
- (b) Roof leaders shall not be directed onto driveways which drain directly onto *District* right-of-way, including *roads*, or to areas draining directly onto neighboring properties.

**4.5.5.4. Size**

- (a) Service connections shall be sized to accommodate peak design flow, subject to the following minimum pipe diameters:
- from Single Family or Low Density Multi-Family *lots* – 100 mm
  - from Medium or High Density Multi-Family *lots* – 150 mm
  - from Commercial, *Industrial*, or Institutional *lots* – 150 mm

**4.5.5.5. Location and Depth**

- (a) As a general rule service connections shall be located at the lowest corner of the property and installed at an offset of 4.0 m from the property pin.
- (b) Minimum depth will depend on the frost depth, but should be at least 0.9 m where subsurface building floor space is not required. Where basements are proposed, the depths of the storm sewers and services shall be increased to suit.

**4.5.5.6. Grade**

- (a) Service connections shall have the following minimum grades:
- 100 mm diameter pipe: 2%
  - 150 mm diameter pipe: 1.00%
  - Larger sizes: Grade based on minimum velocity of 0.75 m/s.

**4.5.5.7. Connections to Mains**

- (a) For connections to new mains, use standard wye fittings.
- (b) For connections to existing mains, use wye saddles or, if approved, insertable tees.
- (c) Service connections may be permitted into manholes if
- (d) the connection is not oriented against the flow in the main and
- (e) manhole hydraulic requirements are met.
- (f) Storm services to properties shall not be permitted from storm drains located in rights-of-way unless a clean-out is provided and the nature of the *development* will permit access to the right-of way for inspection, maintenance, and repair.
- (g) Include an inspection chamber unless service is less than 2.5 m long and connects to a manhole.
- (h) Service connections shall be designed as mains if they exceed 30 m in length.

#### 4.5.5.8. Maintenance Access

- (a) Manholes are required for services relative to the size of the main as shown in Summerland Standard Drawings.

#### 4.5.6. Sub-Surface Disposal / Infiltration Facilities

##### 4.5.6.1. General

- (a) Infiltration facilities are intended to reduce offsite-discharge volumes and rates, and to promote groundwater recharge. They are suitable for high permeability soils with low groundwater elevation, but must be supported by a hydrogeological study for confirmation and design guidance. Requirements to incorporate recharge systems in the design shall be reviewed and approved by the *Director* on a site specific basis.
- (b) Design details should be in accordance with current technologies as outlined in Infiltration Systems guidelines in Land *Development* Guidelines for the Protection of Aquatic Habitat (Canada/B.C.), and related documents such as the *MMCD* Green Design Guideline Manual.
- (c) The *Consulting Engineer* shall submit all sizing assumptions and calculations for review and approval by the *Director*.
- (d) Under no circumstances shall these systems or controls be used in the following conditions:
- (i.) Areas within 30 m of a slope that is steeper than 3.0 (horizontal) to 1.0 (vertical) and higher than 6.0 m, or a slope that has been assessed to be unstable or potentially unstable by a Qualified Professional.
  - (ii.) Areas where the post-*development* wet season groundwater table is less than 0.6 m below the base of proposed infiltration system or infiltrating surface.
  - (iii.) Areas where existing dwellings do not have foundation drains.
  - (iv.) Bedrock or other impermeable layer is located within 1.2 meters of the bottom of the infiltration system.
  - (v.) The infiltrating surface is located on top of fill material.
  - (vi.) The adjacent or underlying soils have a fully saturated percolation rate of less than 10 mm/hr.
  - (vii.) Site is sensitive to potential groundwater contamination.

##### 4.5.6.2. Infiltration Rate Correction Factor

- (a) A correction factor, or factor of safety, is commonly applied to measured infiltration rates for design purposes. These correction factors are intended to mitigate the following:
- Long-term silting or “blinding” of the facility.
  - Potential variability in the subsurface conditions.
  - Type and size of infiltration facility.
  - Whether it is public or private.
- (b) The correction factor is applied as follows:

## Equation 4-6

$$K_{\text{Design}} = K_{\text{Field}} / \text{SF}$$

Where:  $K_{\text{Design}}$  = the design infiltration rate (mm/hr)  
 $K_{\text{Field}}$  = the infiltration rate as determined by field tests (mm/hr)  
SF = the Safety Factor

- (c) The Safety Factor shall be recommended by the geotechnical Engineer, but shall not be less than 2.0.

**4.5.6.3. Drywells**

- (a) Drywells are suitable for areas with low groundwater tables as part of an on-site storm water management plan for the minor system. The minimum number of dry wells must be determined by considering the flow generated from the site in relation to the intake capacity of the soil in the dry well structure. Sufficient temporary storage (within the drywell, surrounding drain rock, and potentially on the surface) shall be *constructed* to contain generated flows until such time as they infiltrate into the subsurface. Design shall be in accordance with Standard Drawings.

**4.5.6.4. Perforated Pipes**

- (a) Perforated pipes within infiltration trenches are suitable for only undisturbed ground where water can move horizontally out of the trench and where drainage water is free from silts. The system must be designed to function under surcharged conditions, and are therefore more suitable to locations with flatter slopes. Where necessary, this type of infiltration system shall include internal overflows within each manhole. Design shall be in subject to approval by the *Director*.

**4.5.6.5. Infiltration Basins / Manufactured Systems**

- (a) Surface infiltration basins shall be designed in accordance with the guidelines referenced in this Schedule. Pre-manufactured modular infiltration chambers shall be designed as per manufacturer's recommendations. Shop drawings for such systems shall be provided, and shall reflect site conditions, including invert elevations and layout dimensions. Details regarding inspection and maintenance access shall also be provided.
- (b) The design shall include provision for system failure and overflow under Major Storm conditions.
- (c) The design shall include an operations and maintenance manual, along with an estimate of annual O&M costs.

**4.5.6.6. Pre-Treatment**

- (a) Particularly in multi-family, commercial, institutional, and *industrial developments*, all infiltration systems shall include pre-treatment measures to remove sediments, suspended solids, and oils and greases prior to entering the infiltration *zone*. This is especially a concern in areas with new *development* until landscape vegetation has matured. Pre-treatment design shall be in accordance with requirements of the *Director*.



**4.5.7. Outfalls**

- (a) Outfalls of a storm sewer system into *watercourses* shall be designed recognizing aesthetics and erosion control. All new all storm water outfalls to natural *watercourses* or water bodies must be approved by the appropriate provincial and federal authorities. In cases where the receiving water is classified as a navigable water way, approval may also be required from the Canadian Coast Guard.
- (b) Outfalls into lakes shall be submerged, extended from shore, and shall be *constructed* to have minimum bury according to the following:
- soft bottom, 0.6 metres to allow for seasonal sand erosion and deposition
  - rock bottom, criteria to be confirmed by Canadian Coast Guard
  - exposed pipes must be a minimum of 2.4 metres deep during lake “low water”
- (c) Where a storm sewer discharges into a natural *watercourse* or open channel, provide riprap bank protection and, if necessary, energy dissipation facilities. Avoid discharge perpendicular to stream flow.

**4.5.8. Culverts****4.5.8.1. General**

- (a) Culvert design shall be in accordance with the procedures outlined in the most current edition of a generally accepted design manual including, but not limited to:
- American Concrete Pipe Association – Concrete Pipe Design Manual
  - Corrugated Steel Pipe Institute – Handbook of Steel Drainage and *Highway Construction Products*
  - BC Supplement to TAC Geometric Design Guide.
- (b) Where the referenced design guideline contradicts the requirements of this Schedule, the more conservative requirement shall govern.

**4.5.8.2. Minimum Diameters**

- (a) crossing residential driveways – 400 mm
- (b) crossing commercial, *industrial*, or institutional driveways – 450 mm
- (c) crossing public *roads* – 600 mm
- (d) on a stream, regardless of *road* or driveway classification – 600 mm

**4.5.8.3. Hydraulic Design**

- (a) The following Manning’s roughness coefficients shall be used for circular culverts:
- 0.011 for smooth-walled PVC or HDPE
  - 0.013 for smooth-walled concrete

- 0.023 for corrugated HDPE
  - 0.024 for corrugated metal
- (b) Use manufacturer's recommended roughness coefficients for non-circular culverts.
- (c) Driveway culverts that form part of the Minor system shall be designed to convey runoff from the Minor Storm with a maximum headwater to diameter ratio (Hw/D) of 0.5 – measured from the culvert invert at the inlet.
- (d) Culverts crossing *roads* shall be sized to convey the design flow with a maximum headwater to diameter ratio (Hw/D) of 1.0 – measured from the culvert invert at the inlet.
- (e) The design shall consider both inlet and outlet control – and shall be based on the condition requiring the larger diameter.
- (f) Culverts shall be *constructed* with inlet and outlet structures for all land uses except the “*Rural*” land use as shown in **Schedule A: Map A-2**. Culverts within the *Rural* areas shall be *constructed* with inlet and outlet structures at the discretion of the *Director*.
- (g) When culverts or storm pipes are greater than 600 mm, the outfall pipe or structure shall be protected against entry by a free swinging, lockable, weighted grating which will allow passage of materials on discharge.
- (h) Inlet and outlet structures shall be *constructed* in accordance with Standard Drawings.
- (i) Energy dissipation and erosion control at culvert outfalls shall be considered in the design.

#### 4.5.8.4. Depth and Cover

- (a) The minimum depth of cover over culverts is 0.3 metres, subject to the manufacturer's loading criteria.
- (b) Culvert invert elevations shall be no lower than the corresponding design elevation of the ditch bottom. Where there is insufficient depth to maintain minimum cover, two or more culvert barrels may be installed to convey the design flow.

## 4.6. Major System

### 4.6.1. General

- (a) Storm runoff generated by less frequent, higher intensity rainstorms may exceed the capacity of the Minor System. Runoff from these events will pond in depressions and follow whatever overflow route is available. This network of ponding and overland flows is called the “Major System”. It may be comprised of some, or all of the components found in the Minor System, but sized to convey or otherwise accommodate the Major Flow. The Major System may also include *road* surfaces, overland drainage routes, and surface ponding. If the Major System is properly planned, it can minimize or even eliminate the potential inconvenience and property damage caused by large rainfall events or when inlets to the minor system become blocked by debris.

- (b) Even though storm sewers can function as part of the Major System, this is not encouraged. Using pipes to convey Major Flows may be implemented in special circumstances, but only with the approval of the *Director*.

#### 4.6.2. Surface Flow Routing

- (a) Roadways with curbs and gutters may be designed as wide channels to convey major surface flow. In this case, the *Consulting Engineer* will consider the impact of surface routing on the major flow hydraulic grade line (HGL) of adjacent lateral roads. Existing lateral roads designed with the major HGL below surface may preclude using surface flow routing on the road being designed. Use of barrier curbs for major surface flows on roads is preferred, but rollover curbs may be used with approval of the *Director*.
- (b) The design of the intersections will ensure that the surface flow can continue along the designated path crossing over lateral roads. Similar considerations are required if a change of surface flow direction is required at an intersection.
- (c) Calculations to verify that the surface flow is maintained within the road right-of-way and that the water elevation at maximum ponding/flow is at least 0.30 metres below the lowest Minimum Building Elevation (MBE) of adjacent buildings shall be provided with the design.
- (d) The following criteria for routing major design flows on road surfaces with an urban cross section shall be met:
- For all classes of roads, the flow/ponding depth shall not exceed 0.150 m above gutter line nor overtop the curb, whichever governs.
  - Flow velocities greater than 2.5 m/s must be approved by the *Director*.
  - On local roads, the flow may spread to the crown.
  - On collector roads, the flow spread must leave one lane or a road surface equivalent free of water to ensure access for emergency vehicles (fire, ambulance).
  - Flooding is not permitted on private property except in flow channels within dedicated rights-of-way.

#### 4.6.3. Ditches

##### 4.6.3.1. General

- (a) Roads with rural cross-sections shall be constructed with ditches that ensure adequate road subgrade drainage (in compliance with standard road design). Ditch design shall conform to the criteria specified below. Variations may be implemented with appropriate justification by the *Consulting Engineer* and approval of the *Director*.
- Minimum slope: 0.5% (0.005 m/m)
  - Minimum depth: 0.3 m below road sub-grade
  - Minimum freeboard: 0.3 m
  - Maximum flow depth: 0.6 m
  - Minimum bottom width: 1 m
  - Maximum side slopes: 2:1 (H:V)

**4.6.3.2. Surface Flow Capacity**

- (a) Table 4.7 provides acceptable Manning’s “n” values for *road* surfaces, ditches, and swales, which shall be used with the Manning Formula for design and assessment of these structures.

**Table 4.7: Open Channel Roughness Coefficients**

Condition	Manning’s “n”
Concrete curb and gutter	0.013
Asphalt <i>roadway</i>	0.015
Grassed boulevards and swales	0.040
Ditches – gravel / small cobbles	0.027
Ditches – vegetated	0.035
Ditches - Rip-Rap (Class 10 kg / D <sub>50</sub> 200mm)	0.070
Ditches - Rip-Rap (Class 25 kg / D <sub>50</sub> 300mm)	0.072
Ditches - Rip-Rap (Class 50 kg / D <sub>50</sub> 350mm)	0.075
Ditches - Rip-Rap (Class 100 kg / D <sub>50</sub> 450mm)	0.077

- (b) Roughness coefficients for conditions not listed in Table 4.7 shall be determined by the *Consulting Engineer* and submitted for approval by the *Director*.

**4.6.4. Swales**

- (a) Swales shall be lined with turf on a minimum of 100mm of topsoil or lined with an erosion protection system approved by the *Director*. All such swales serving two or more *parcels* of property shall be sized to accommodate the Major Design flow, and shall meet the following criteria:

- Minimum slope: 1.0% (0.01 m/m)
- Minimum freeboard: 0.15 m
- Maximum flow depth: 0.3 m
- Maximum side slopes: 4:1 (H:V)

- (b) All swales to be owned and operated by the *District* shall be located within a Statutory Right of Way (SROW).

**4.6.5. Culverts**

**4.6.5.1. General**

- (a) In addition to the design requirements presented in Section 4.6, Major System culverts shall also be designed according to the following:
- Trash racks and/or debris barriers may be required upstream of culvert installations, as directed by the *Director*.

## 4.6.5.2. On Streams

- (a) In addition to the design requirements presented in Section 4.6, culverts on streams shall also be designed according to the following:
- All culverts shall be designed to convey the instantaneous 200-year return period flow or greater.
  - Inlet and outlet structures are required for all culverts on streams, unless otherwise directed by the *Director*.
  - Culverts on fish-bearing streams shall meet conditions as specified by municipal, provincial, and federal authorities. Such culverts will be required to allow safe fish passage, and habitat restoration works will generally be required. The *Consulting Engineer* shall confirm and implement these requirements with the appropriate agencies.

## 4.6.6. Piped Systems

- (a) In special circumstances, or to accommodate lower building elevations, Minor System storm sewers may be enlarged or supplemented to accommodate major flows. System details shall be indicated in the Storm Water Management Plan and approved by the *Director*. Design shall include:
- Provision of adequate inlets to accommodate major flows – including flows carrying suspended sediment and debris
  - Surface overflow routes at potential surface ponding locations
  - Compliance with minor drainage system guidelines.

## 4.6.7. Overflow Flow Routes

- (a) Sags or low points in *roads* and *cul-de-sacs* must be designed with a safe overflow route to an approved receiving water or to adequately sized drainage infrastructure. These overflow routes may be ditches or swales and shall be designed as per Sections 4.6.3 and 4.6.4 respectively. The overflow route shall also be located within a right-of-way in favour of the *District*, with a minimum width of 4.5 m.
- (b) Where a ditch crosses private property, the ditch shall be offset in the right-of-way to permit a 3.0 metre wide access for maintenance vehicles. Additional right-of-way may be required to facilitate the ditch *construction* and access. The top of the ditch adjacent to the property line shall be a minimum 0.5 metres away from that property line, and the design HGL shall be at least 0.6 m below the MBE of adjacent buildings. Ditches shall be designed to maximize infiltration where infiltration is appropriate as per Section 4.6.4.

## 4.6.8. Discharge to Natural Watercourses

- (a) Storm discharge rates and volumes to natural *watercourses* shall be controlled to prevent damage to the natural channel and harm to the ecological system. Designs must conform to all applicable federal, provincial, and municipal laws and regulations. The *Owner* shall submit the designs to, and obtain comments and approvals from, the appropriate provincial and/or federal agencies.

## 4.6.9. Subsurface Disposal / Infiltration Systems

- (a) If a geotechnical study indicates that soil conditions are suitable to support infiltration-based disposal of Major System flows, then such system shall be designed in accordance with this Schedule.

## 4.7. Detention Facilities

### 4.7.1. General

- (a) It is usual to provide detention storage facilities in conjunction with flow control. Such facilities temporarily store the volume of runoff corresponding to the condition where the inflow rate exceeds the controlled discharge rate.
- (b) The number of storage facilities shall be minimized, and where feasible, shall be owned and operated by the *District*. All storage not under private ownership shall be dedicated to the *District* (including berms, structures, access, etc.).
- (c) Storage facilities may be surface or underground and may be “online” or “offline”.
- (d) Design details, other than discharge rates, should be in accordance with current technologies as outlined in Land *Development* Guidelines for Protection of Aquatic Habitat (Canada/B.C.), and related documents. Design for specific types of detention storage shall also reflect the following requirements.

#### 4.7.1.1. Parking Lot Storage

- (a) Requires detailed *lot* grading design to ensure proper drainage, pedestrian safety and convenience, and major flow paths.
- (b) Maximum ponding depth: 300 mm outside vehicle stalls, 150 mm within vehicle stalls, however, also with consideration to frequency of ponding and impact to users of the parking *lot*.

#### 4.7.1.2. Underground Storage

- (a) Facilities include tanks and oversized pipes, with outlet controls.
- (b) Cross sections and inlet and outlet locations shall be designed to minimize maintenance requirements.
- (c) Structural design to accommodate traffic loads and groundwater pressure.
- (d) Maintenance access provisions required.

#### 4.7.1.3. Dry Detention Ponds

- (a) An off-line pond is preferred, but an on-line facility may be considered at the discretion of the *Director*.

- (b) Fencing and graded slopes required as per referenced design guidelines.
- (c) May accommodate active recreational uses.
- (d) Overflow elevations to be coordinated with MBEs.
- (e) Provide warning signage indicating facility is a stormwater detention structure subject to flooding or rapid water level changes. Signs to be posted at all public access points or *road frontages*.

**4.7.1.4. Wet Detention Ponds**

- (a) Intention is to provide on-line detention storage and maintain a permanent minimum water levels.
- (b) Catchment area must be large enough to provide sufficient base flow to ensure wet storage and is sustained without becoming stagnant (based on local hydrologic characteristics).
- (c) Fencing and graded slopes required as per referenced design guidelines.
- (d) Can provide a public amenity within a passive park.
- (e) Overflow elevations to be coordinated with MBEs.
- (f) Provide warning signage indicating facility is a stormwater detention structure subject to flooding or rapid water level changes. Signs to be posted at all public access points or *road frontages*.

**4.7.2. Flow Controls**

- (a) Control structures shall be used to provide consistent flow control as specified in Section 4.2. These structures shall be designed to include multi-stage controls. For example, two or more orifices located vertically on a control structure can be designed to provide increasing discharge rates as the water level rises. Safe overflow must be provided for conditions that exceed the maximum design flows.
- (b) Flow controls may be designed using the standard orifice and weir equations:

**Equation 4-7**

Orifice Equation:  $Q = CA(2gh)^{0.5}$

- Where: Q = release rate (m<sup>3</sup>/s)
- C = orifice coefficient (0.62 for sharp or square edge)
- A = area of orifice (m<sup>2</sup>)
- g = gravitational acceleration (9.81 m/s<sup>2</sup>)
- h = net head on orifice (m)

**Equation 4-8**

Weir Equation:  $Q = CLH^{1.5}$

Where: Q = release rate (m<sup>3</sup>/s)  
C = weir coefficient (to be determined by the *Consulting Engineer*, subject to approval)  
L = effective length of weir crest (m)  
H = net head on weir crest (m)

- (c) Release rates which do not reflect the criteria specified in Section 4.2 may be allowed or required by the *Director*, depending on downstream conveyance system capacity, stream protection, flood protection, and/or water quality issues.

### 4.7.3. Sizing

- (a) The design volume for detention facilities shall be determined using the Hydrograph Method and shall be the largest peak storage volume required to control flows as per the criteria specified in **Table 4.2**. A 10% volumetric safety factor shall be applied to the calculated maximum volume. Rooftop or parking *lot* storage may be included in storage sizing calculations with the approval of the *Director*. All sizing assumptions and results shall be provided as part of the design submission.

### 4.7.4. Inlet / Outlet Considerations

- (a) Design of inlet and outlet structures shall include consideration of energy dissipation and erosion control. Safety grates are required over all inlet and outlet openings larger than 500 mm diameter. Locks for access hatches are required.

### 4.7.5. Geotechnical Considerations

- (a) Wherever possible, the stormwater storage facility shall be excavated in natural, stable ground. Should topography dictate that a berm be *constructed* along one or more sides of a surface facility (dry or wet pond), the berm shall be designed by a Qualified Professional.

### 4.7.6. Ownership

- (a) For storage not under private ownership, all accesses to inlets/outlets, any structures and maintenance access routes to the facility shall be dedicated to the *District*. Land that is adjacent to a storage facility which is subject to flooding as per the design standard established, but which is part of the privately-owned *parcel* being developed, will be required to dedicate rights-of-way, to allow for encroachment of water onto the affected land. The right-of-way documents shall be prepared by the *Owner*, naming the *District* as grantee.
- (b) A restrictive covenant shall be placed on *lots* abutting the facility to control *lot development* so as not to compromise design requirements at the high-water level for major runoff events. This is to ensure an adequate freeboard is maintained.
- (c) The *Owner* confirm the need for an operational license for any wetland style storage or treatment facility with the appropriate municipal, provincial, or federal agency, and shall apply for and secure such license.



**4.7.7. Operations & Maintenance**

- (a) An Operations & Maintenance Manual for each type of detention storage facility must be provided. This shall include details of the system components and inspection and maintenance requirements in terms of tasks and frequencies.
- (b) Suitable maintenance vehicle access from a public *road* to the detention facility shall be provided and protected by a right-of-way in favour of the *District*.
  - For surface facilities (dry ponds), access shall include provisions for maintenance vehicles to access the pond.
  - For buried facilities, access shall include adequate provisions to inspect and maintain the facility as per the required Operations & Maintenance Manual.

**4.7.8. Emergency Overflow Provisions**

- (a) If overflow is not provided as part of the flow control structure, then an adequate emergency overflow must be provided as part of the detention facility design. An adequate surface flow route from the overflow structure to the designated Major Drainage route must be provided and must be located within a public or *District*-owned right-of-way.

**4.7.9. Rapid Drawdown**

- (a) The ability to discharge from storage facilities at the maximum flowrate that the downstream system can accommodate after storm runoff peak flows have passed, and the flows from other contributing areas have decreased or ended, shall be provided. The discharge rate for drawdown purposes shall be sufficient to restore available storage capacity in the facility to sufficiently control runoff from subsequent storm events within a reasonable time frame as per Table 4.8.

**Table 4.8 Drawdown Provisions**

Time After Commencing Drawdown From Full Level	Available Volume Required Below Design Full Level
24 hours	Volume equivalent of 1 in 10-year, 24 hour run-off
72 hours	100% of total storage volume

**4.7.10. Temporary Conditions**

- (a) Where land *developments* occur in advance of permanent detention facilities, the *District* may consider temporary storage facilities on an individual basis. Maintenance charges and responsibility for temporary storage facilities will be borne by the developer.

**4.8. Sediment and Erosion Control**

**4.8.1. General**

- (a) Erosion control shall be incorporated into the design of all open channel conveyance routes and at all outfall / discharge locations. Typical erosion control methods include, but are not limited to vegetation, root-reinforced vegetation, manufactured materials and systems, rip rap, and velocity control.

- (b) The *Owner* must also ensure that no silt, gravel or debris resulting from *construction* activity in the *subdivision* or *development* is allowed to discharge into existing drainage systems, natural drainage courses, water courses, or onto *highways* or adjoining properties.

**4.8.2. Open Channels**

- (a) Earthen open channels such as ditches and swales shall be designed to prevent incising, erosion, and movement of sediment. Such design is dependent on soil characteristics, channel lining, channel slope, flow depth, and flow velocity. Generally, open channels shall be designed to meet the maximum velocities specified in Table 4.9.

**Table 4.9: Permissible Open Channel Velocities (Fully Vegetated / Grass-Lined)**

Earth – Soil Type	Permissible Velocity (m/sec)		
	<0.5%	5-10%	>10%
Longitudinal Channel Slope			
Erosion Resistant Soils	1.2	0.9	0.7
Highly Erodible Soils	0.9	0.7	0.5

- Highly erodible soils include Fine Sand (non-colloidal), Sandy Loam (non-colloidal), Silt Loam (non-colloidal), and Ordinary Firm Loam.
  - Erosion resistant soils include Fine Gravel, Stiff Clay (very Colloidal), Graded Loam to Cobbles (non-colloidal), Graded, Silt to Cobbles (colloidal), Alluvial Silts (non-colloidal), Alluvial Sites (colloidal), Coarse Gravel (non-colloidal), Cobbles, and Shales and Hard Pans.
- (b) Where soil conditions are suitable, or where erosion protection is provided, higher velocities may be permitted at the discretion of the *Director*. In some circumstances, more rigorous analysis using shear stress and soil characteristics provided by a Geotechnical Engineer, based on field investigation, may also be required at the discretion of the *Director*.
  - (c) Bare-earth open channels will not be permitted, and must be vegetated or otherwise protected from erosion using rip-rap lined bottoms and sides, erosion control structures, geo-fabrics, or other methods approved by the *Director*.
  - (d) Erosion control calculations shall be submitted with the design. Rip rap design shall be conducted using methods presented in the most current edition of the BC Supplement to TAC Geometric Design Guide.

**4.8.3. Development Site**

- (a) All proposed *subdivision* or *development* projects must provide sediment and erosion controls to prevent the displacement of soil and the transport of sediment from the project site resulting from land disturbing activities. This applies, but is not limited to, areas that are cleared and grubbed, slope cuts, fills, and stockpiled materials such as sand, gravel, native soils, and topsoil. To prevent soil displacement and the sediment transport during land-disturbing activities, erosion and sedimentation control measures are required and shall be performed as described below. Both temporary and permanent sediment and erosion controls both during *construction* and *post-construction* shall be implemented.

**4.8.3.1. Sediment and Erosion Control Plan**

- (a) The *Consulting Engineer* must submit Drainage, Sediment and Erosion Control Plan detailing sediment and erosion control measures. These control measures shall conform to the details and specifications in *District* Bylaws and policies unless an alternative is approved by the *Director*.

**4.8.3.2. Clearing Limits**

- (a) Prior to any site clearing or grading, areas to remain undisturbed during project *construction* shall be delineated and marked on-site by flagging or other method. At a minimum, clearing limit delineation shall be installed at the edges of all sensitive area buffers. Retain existing vegetation, where possible.

**4.8.3.3. Cover Measures**

- (a) Temporary and/or permanent cover measures shall be provided when necessary to protect disturbed areas as detailed in the sediment and erosion control documents.

**4.8.3.4. Perimeter Protection**

- (a) Perimeter protection to contain sediment from sheet flow shall be provided downslope of all disturbed areas where necessary as detailed in the sediment and erosion control documents. Such protection shall be installed prior to upslope grading. Perimeter protection includes the use of vegetated strips as well as more conventional *constructed* measures such as silt fences.

**4.8.3.5. Traffic Area Stabilization**

- (a) Unsurfaced entrances, *roads*, and parking areas used by *construction* traffic shall be stabilized to minimize erosion and tracking of sediment off site as detailed in the sediment and erosion control documents.

**4.8.3.6. Sediment Retention**

- (a) Surface water collected from disturbed areas of the site shall be routed through a sediment pond or trap prior to release from the site as detailed in the sediment and erosion control documents, except areas at the perimeter of the site small enough to be treated solely with perimeter protection. Sediment retention facilities shall be installed prior to grading of any contributing area.

**4.8.3.7. Surface Water Controls**

- (a) Surface water controls shall be installed to intercept and convey all surface water from disturbed areas to a sediment pond or trap. Significant sources of upslope surface water that drain onto disturbed areas shall be intercepted and conveyed to a stabilized discharge point downslope of the disturbed areas.

#### 4.8.3.8. Construction Within Environmentally Sensitive Areas

- (a) Unless a higher standard is required by a senior level of government, any *construction* that will result in disturbed areas on or within a stream or associated buffer, within a wetland or associated buffer, or within 15 metres of a lake or other water way shall be subject to “best management practices” including but not limited to “Urban Runoff Quality Control Guidelines for the Province of British Columbia from the Municipal Waste Branch Environmental Protection Division BC Environment” (June 1992) for erosion and sediment control.

These provisions include phasing the project whenever possible so that *construction* in these areas is limited to the dry season.

#### 4.8.3.9. Maintenance

- (a) All erosion and sedimentation control measures shall be maintained as per the erosion and sedimentation control plans submitted by the *Consulting Engineer*. The *Owner* shall ensure that regular inspection and maintenance of these works are completed in a timely manner to ensure compliance with all conditions relating to erosion and sedimentation control until Substantial Completion is obtained.

#### 4.8.3.10. Final Stabilization

- (a) Prior to obtaining Substantial Completion, the site soils shall be stabilized and the structural sediment and erosion controls (such as silt fences and sediment traps) shall be removed. Drainage facilities shall be cleaned as specified by the *Director*. At the discretion of the *Director*, some erosion and sedimentation control measures (such as catch basin filters) may be required during the full *Maintenance Period*. If so, the *Owner* shall be responsible for periodic inspection and maintenance of these installations, and for their ultimate removal, until the end of the *Maintenance Period*.

### 4.9. Stormwater Quality

#### 4.9.1. General

- (a) Several potential organic and inorganic substances can be found in rainwater runoff and are referred to as “non-point source” (NPS) pollution because the sources tend to be highly dispersed across the landscape. The ones of greatest relevance and which are targeted for treatment are:
- Total suspended solids (TSS)
  - Oil and grease (O&G)
  - Trace metals, typically represented by copper and zinc
- (b) Focusing on the removal of these constituents is expected to yield adequate removal of other associated constituents.

**4.9.2. Sizing**

- (a) All *developments* shall incorporate water quality treatment provisions into the design to meet the performance targets provided in this section. The targets are expected to be met for every new *development* and *redevelopment* site by implementing Best Management Practices (BMPs). Facilities shall be sized to adequately treat the following:
- 70% of the 2-year, 24-hour post-*development* runoff volume when using a single-event design approach, or
  - 90% of the average annual post-*development* runoff volume when using continuous simulation for design.

**4.9.3. Performance Targets**

- (a) The performance targets are classified as “Basic Control”, which address suspended solids, and “Hydrocarbon Control”, which addresses oils and grease. These targets shall apply to all stormwater discharges from the *subdivision* or *development*, including discharges to a receiving water and offsite discharges.

**4.9.3.1. Basic Control**

- (a) Basic treatment focuses on removal of Total Suspended Solids (TSS) along with associated pollutants attached to those sediments, including low levels of petroleum hydrocarbons (oil and grease). Basic control is applicable to all non-agricultural lands within the *District* and must provide treatment for:
- 80% removal of TSS.
- (b) Discharge from the treatment system must meet the BC Recreational Water Quality Guidelines for turbidity.

**4.9.3.2. Hydrocarbon Control**

- (a) Hydrocarbon (oil and grease) removal is specifically required for sites where there is significant likelihood that higher concentrations of petroleum hydrocarbons will be released; in general, this includes sites with significant presence or use of vehicles. The performance target is:
- No on-going or recurring visible sheen in receiving *watercourse(s)*, and
  - 24-hour average Total Petroleum Hydrocarbon (TPH) concentration no greater than 10 mg/L with a maximum discrete (grab sample) concentration no greater than 15 mg/L.
- (b) The catchment area to the treatment system may be restricted to drives, *roads*, and parking areas.

**4.9.4. Best Management Practices**

- (a) Table 4.10 shows how these performance targets are to be applied to various land uses as well as the Best Management Practices (BMPs) presumed to achieve the performance targets if properly designed, installed, and maintained. In all cases, rainwater source controls and landscape-based, surface-oriented BMPs will be encouraged over below ground, manufactured

# Schedule C

**District of Summerland**  
**DESIGN STANDARDS**  
**4 – Stormwater Management**

(or engineered) devices. This list is not exhaustive, and alternatives may be used subject to approval by the *Director*.

- (b) Proposed use of manufactured devices must be accompanied by documentation of performance from a reputable testing or certification program<sup>1</sup>. Performance testing and/or monitoring may be required during the *Maintenance Period* at the discretion of the *Director*.

**Table 4.10 Performance Targets by Land Use Classification**

LAND USE CLASSIFICATION	TARGETS	APPLICABLE BMPs
Residential - Single Family	Basic	Rain Gardens Vegetated Bioswales Porous Asphalt Drives, Sidewalks, Parking Areas Sand Filters Filter Strips Stormwater Treatment Wet Ponds Stormwater Treatment Wetlands Manufactured TSS Removal Systems <sup>2</sup>
Residential - Multi-Family	Basic + Hydrocarbon Control	Oil/water separator (API or coalescing plate type) <sup>3</sup> , plus BMPs listed under “Residential – Single Family”
Commercial – offices with primarily employee daily parking	Basic	Same as those listed under “Residential – Single Family”
Commercial – retail use with significant daily traffic (>100 vehicles per 100 m <sup>2</sup> of building) - Includes service station(s)	Basic + Hydrocarbon Control	Same as those listed under “Residential – Multi Family”
Industrial – medium intensity use, with truck traffic and employee daily parking	Basic + Hydrocarbon Control	Same as those listed under “Residential – Multi Family”
Industrial – high intensity use <ul style="list-style-type: none"> <li>• Industrial machinery &amp; equipment, and railroad equipment maintenance</li> <li>• Log storage and sorting yards</li> <li>• Railroad yards</li> <li>• Fueling stations</li> </ul>	Basic + Hydrocarbon Control	Oil/water separator (API or coalescing plate type) plus: Stormwater Treatment Wetlands Stormwater Treatment Wet Ponds Manufactured TSS Removal Systems <sup>3</sup>

# Schedule C

## District of Summerland DESIGN STANDARDS

### 4 – Stormwater Management

<ul style="list-style-type: none"> <li>• Vehicle maintenance and repair</li> <li>• <i>Construction</i> businesses</li> </ul>		Subsurface Infiltration (requires pre-treatment) Sand Filters Amended Sand Filters
Institutional (Schools; government; hospitals; cultural buildings)	Basic + Hydrocarbon Control	Same as those listed under “Residential – Multi Family”
Parks and Open Space (Buildings, parking <i>lots</i> and other hard surfaces)	Basic	Same as those listed under “Residential – Single Family”
<i>Roads &amp; Streets</i> – low intensity use (<15,000 ADT) <ul style="list-style-type: none"> <li>• Local roads</li> <li>• <i>Lanes</i></li> </ul>	Basic	Same as those listed under “Residential – Single Family”
<i>Roads &amp; Streets</i> – high intensity use (>15,000 ADT) <ul style="list-style-type: none"> <li>• Collectors</li> <li>• High use intersections (&gt;15,000 ADT on main <i>road</i>; &gt;10,000 ADT on intersecting <i>road</i>)</li> </ul>	Basic + Hydrocarbon Control	Same as those listed under “Industrial – High Intensity Use”
Agricultural	Follow Applicable Provincial Rules and Guidelines for Agricultural Lands	

1 These programs include, in order of preference, (1) Canadian Environmental Technology (ETV) Program; (2) State of Washington (USA) Technology Assessment Protocol – Ecology (TAPE) program; and (3) Technology Acceptance and Reciprocity Partnership (TARP) Protocol for Stormwater Best Management Practice Demonstrations. Other testing or certification programs administered by third parties, such as universities or independent testing labs, may also be acceptable, at the discretion of the *Director*.

1 Including media filter and membrane filter systems as well as manufactured biofiltration systems, at the *District's* discretion.

1 Requirement for an oil/water separator at multi-family residential sites may be waived at the *District's* discretion, if a *development* or *redevelopment* proponent can show that the site design has minimized impermeable surfaces and arranged buildings, *roads* and parking elements in a manner similar to single-family residential areas. Typically, this will mean that total impermeable surfaces constitute less than 50% of the site and, more specifically, that large open parking *lot* areas must not be present. For purposes of rainwater management, impermeable surfaces includes all buildings, patios, decks, driveways, sidewalks and parking areas on a single property; note that this is different than “*parcel coverage*” as defined in the *District's* Zoning Bylaw.

#### 4.9.5. Additional Requirements

(a) All stormwater quality installations shall:

- (i.) Provide a high flow bypass that regulates the flow rate into the treatment unit and conveys high flows directly to the outlet such that scour and re-suspension of material previously collected does not occur.
- (ii.) Provide maintenance access both to the structure and within the structure so that accumulated debris, oils, and sediments can be readily removed with a vacuum truck.

- (iii.) Meet H-20 loading criteria when located where vehicles can pass over the structure.
- (iv.) Joints and fittings shall be oil resistant and watertight.

## 4.10. Pumping Systems

### 4.10.1. Lift Stations

- (a) Drainage pump stations are not commonly used within the *District*. Where drainage pumping is required, however, the *Consulting Engineer* must review the proposed concept and design criteria with the *Director*, submit a pre-design report, and obtain approval from the *Director* before proceeding with design. At a minimum, the pre-design report should include the following:
  - (i.) Delineated catchment area map
  - (ii.) Estimated flows and operating head / HGL
  - (iii.) Pump station location
  - (iv.) Connection point to existing infrastructure.
- (b) Stormwater lift stations shall be designed as per the requirements for sanitary lift stations (except where not applicable to stormwater) as presented in Schedule C of this bylaw.

### 4.10.2. Sump Pumps

- (a) Permanent groundwater pumping is not permitted to *District* storm sewers.

## 4.11. Hillside Standards

- (a) As per the requirements outlined in Section 5.19 – Hillside Standards, the following drainage considerations shall be made in designated *hillside* areas:
  - (i.) Catchbasin grates on *road* grades exceeding 6% shall slope into (opposite) the downhill *road* grade to catch surface flows.
  - (ii.) High side gutter elevation shall be 75mm above the catchbasin grate.
  - (iii.) Ditching, swales or natural drainage courses exceeding 6% require a ditch cross section that will control erosion taking into account soil type, water flow and velocity.
  - (iv.) Roof leaders and foundations drains shall be discharged to a closed drainage system.



<b>5. Roads</b>	<b>72</b>
5.1. General	72
5.2. Road Classifications	74
5.3. Cross-Section Elements	75
5.4. Alignments	78
5.5. Intersections	80
5.6. Roundabouts	81
5.7. Railway Grade Crossings	82
5.8. Traffic Control Devices	82
5.9. Culs-De-Sac	82
5.10. Traffic Barriers	82
5.11. Sidewalk and Pedestrian Crossings	82
5.12. Cycling Facilities	83
5.13. Transit Facilities	85
5.14. Driveways	86
5.15. Clearances	86
5.16. Underground Utility Locations	87
5.17. Pavement Structures	88
5.18. Bridges	91
5.19. Hillside Standards	91
5.20. Traffic Calming	93
5.21. Street Parking	94
5.22. Retaining Wall Systems and Alterations	95

**5. Roads**

**5.1. General**

- (a) These guidelines are not intended to be a substitute for sound engineering knowledge and experience. *Road* designs shall be prepared under the direction of a design professional who has the appropriate experience and is registered with Engineers and Geoscientists of British Columbia.
- (b) Material in this section of the guideline provides a summary of the current approach to the application of *road* design criteria in British Columbia. The section of the guideline does not repeat elements of guidelines published by third parties but summarizes key geometric elements and refers the user to appropriate supplementary information.
- (c) *Road* design practice acknowledges users other than vehicles and has broadened to consider pedestrians and other active transportation users. Aesthetics of the *roadway* are being considered to a greater degree than in the past and this section addresses some considerations of these users and the associated design elements. Reference can also be made to alternative design guidelines for *developing* approaches to multi-use corridor design.
- (d) These *road* design guidelines refer to *roadways*, *lanes*, sidewalks, pedestrian crossings, and bikeways.

- (e) In addition to these guidelines, *road* designs shall conform to the following guidelines, regulations, and legislation:

Federal

- TAC (Transportation Association of Canada) - Geometric Design Guide for Canadian Roads;
- TAC – Manual of Uniform Traffic Control Devices (MUTCD);
- TAC – Canadian Guide to Traffic Calming;
- TAC – Canadian Roundabout Design Guide;
- TAC – Pedestrian Crossing Control Guide;
- TAC – Canadian Road Safety Audit Guide;
- TAC – Bikeway Traffic Control Guidelines for Canada;
- TAC – Speed Management Guide;
- Canadian Standards Association (CSA) Accessible Design for the Built Environment; and
- Canadian Highway Bridge Design Code.

Provincial

- Motor Vehicle Act;
- Local Government Act;
- Community Charter;
- BC MOTI (BC Ministry of Transportation and Infrastructure) – BC Supplement to TAC Geometric Design Guide;
- BC MOTI – Supplement to Canadian Highway Bridge Code;
- BC MOTI – British Columbia Active Transportation Design Guide;
- BC MOTI – Traffic Management manual For Work on Roadways;
- BC Transit – Infrastructure Design Guidelines; and
- Master Municipal Construction Documents Association, Volume II.

District of Summerland

- Official Community Plan;
  - Zoning Bylaw No 2000-450;
  - Traffic Bylaw No 2386;
  - Transportation Master Plan;
  - Cycling Master Plan;
  - Trails Master Plan;
  - Sidewalk Master Plan; and
  - Driveway Access Bylaw 92-047
- (f) General *road* locations, layouts, and standards shall conform to applicable Summerland plans.
- (g) *Road* layouts in *subdivisions* shall provide for the continuation of projection of existing *roads* in the surrounding areas unless topographical conditions and/or neighbourhood planning objectives make such continuation or projection impractical.
- (h) Local residential *roads* shall be aligned such that low-speed traffic will be encouraged and *road* use by through traffic will be discouraged. Traffic calming measures shall be included where required by the *Director*.

- 
- (i) The *road* design process may need to provide one or more *road* safety audits done in accordance with TAC – Canadian *Road* Safety Audit Guide, when required by the *Director*.
- (j) The design of a retrofit of an existing *road* or intersection may require a review of the collision history to determine how collision risk can be minimized, at the request of the *Director*. The review shall be carried out in accordance with TAC - Canadian Guide to In-Service *Road* Safety Reviews.

## 5.2. Road Classifications

- (a) *Road* classification shall be in general accordance with the design classification system as per the TAC Geometric Design Guidelines Section 1.3.
- (b) The three primary *road* classifications are described as follows:
- An **Arterial Road** operates with the primary function of carrying through traffic from one area to another with as little interference as possible from adjacent land uses. An arterial *road* may provide direct access to property as a secondary function when alternate access is not available. Currently, the *District of Summerland* does not have any arterial *roads* identified in the Transportation Master Plan, except for Highway 97.
  - A **Collector Road** operates with the primary function of distributing traffic between arterial, collector and local *roads* within an area. A collector *road* may also provide direct access to properties.
  - A **Local Road** operates with the primary function of providing direct access to properties. Local *roads* normally connect to other local *roads* or to collector *roads*.
- (c) As per the TAC Geometric Design Guidelines, the above *roads* are further divided into urban and *rural* classifications for geometric design consideration. *Road* classifications should also consider the following facilities:
- A public **Lane** (or alley) is a *roadway* with the primary function of providing land access, typically at the rear of abutting properties. Public *lanes* are not generally intended to carry through traffic. For properties fronting collector or arterial *roads*, rear *lanes* can eliminate the need for front driveways.
  - **Off-Street Pathways** are typically considered an AAA (All Ages and Abilities) facility. They are physically separated from motor vehicles by an open space or a barrier, depending on the application and may or may not be paved.
  - **Primary AAA (On-Street)** routes can include infrastructure such as protected bicycle *lanes*, bicycle boulevards, and buffered bicycle *lanes*.
    - **Protected Bicycle Lanes** are separate travel *lanes* designated exclusively for bicycle use and other forms of active transportation (such as in-line skating, using kick scooters, and skateboarding, where permitted) that are physically separated from motor vehicles and pedestrians by vertical and/or horizontal elements.

- **Bicycle Boulevards or Neighbourhood Bikeways** are streets with low motor vehicle volumes and speeds that are suitable for motor vehicles and people cycling to share the *road*. These facilities may include treatments such as signage, pavement markings, traffic calming, and traffic diversion to prioritize bicycles and make the facility comfortable for people of all ages and abilities.
- **Buffered Bicycle Lanes** are separate travel *lanes* designated exclusively for bicycle use that are delineated by a painted line and, in some cases, a painted buffer area. The painted buffer can be located between the bicycle and motor vehicle *lanes* or between the bicycle *lane* and parked vehicles.

### 5.3. Cross-Section Elements

- (a) Recommended *road* cross-section elements are identified below in **Table 5.1**. Details are in general compliance with the TAC Geometric Design Guide, except as follows:
- Pavement width is measured between curb faces rather than gutter edges as indicated in the TAC guide. This has the effect of making curb *lane* widths appear greater than they appear in the TAC guide. The designer will need to coordinate requirements for curb *lane* widths with the *District of Summerland* to ensure consistency of approach in any given jurisdiction.
  - Overall right-of-way and pavement widths are shown in **Table 5.1**, and are subject to increases to accommodate the following scenarios:
    - Intersections
    - Turn *lanes*
    - Bike *lanes*
    - Bus bays
    - Snow storage
  - Requirements of divided *roads*, street trees, and landscaping are as established by the *District of Summerland* in **Section 8 - Landscaping**. In the absence of specific landscaping requirements, topsoil with sod or hydroseed is required on medians and boulevards. Where the width is insufficient for maintenance of vegetation, hard surfaces may be permitted with the approval of the *Director*.

**Table 5.1 Roadway Cross-Section Details**

Facility Classification	Right-of-Way Width <sup>1</sup> (m)	Pavement Width Curb-to-Curb Width <sup>1</sup> (m)
<b>OTHER</b>		
Lakeshore Drive – no parking	20.00	8.00
Lakeshore Drive – with parking	20.00	12.80
Prairie Valley Road	20.00	10.00
Industrial	18.00	12.00
<b>LANES</b>		
Lane (Centre Swale Drainage)	6.00	6.00
Lane (Cross Fall Drainage)	6.00	5.00
<b>LOCAL ROADWAYS</b>		
Urban Local	16.00	9.30
Rural Local	16.00	8.00
<b>HILLSIDE ROADWAYS<sup>3</sup></b>		
Hillside Local – development both sides	15.0	6.00
Hillside Local – development on one side	14.8	6.00
Hillside Local – no development	13.0	6.00
<b>COLLECTOR ROADWAYS</b>		
Urban Collector – Parking	20.00	12.00/9.50
Urban Collector – No Parking	20.00	7.60
Rural Collector	20.00	10.00

- (1) Right of way widths and pavement widths are calculated as per **Table 5.2** below. This table shows the suggested widths for the median, shoulders, parking lanes, rural ditch, curb and gutter, sidewalk, boulevard, and border.
- (2) The multi-use pathway is based on a two-way path shared between pedestrians and cyclists. Should the pathway requirements be different, the designer may, upon approval by the *Director*, use supporting design guidelines to adjust accordingly.
- (3) Hillside Standards are discussed in **Section 5.19**, pavement width varies based on parking bays.

Table 5.2 Road Cross-Section Derivation

Road Classification	Vehicle Lanes		Shoulders				Parking <sup>1</sup>		Pavement Width	Rural Ditch		Sidewalks		Bicycle Lanes		Boulevards		ROW Width (m)	Drawing #
	#	Width (m)	Gravel		Paved		#	Width (m)		Y/N	Width (m)	#	Width (m)	#	Width (m)	#	Width (m)		
			Y/N	Width (m)	Y/N	Width (m)													
Lakeshore Drive – no parking	2	4.00	N	N/A	N	N/A	N/A	N/A	8.00	N	N/A	2	2.00	N/A	N/A	2	4.00	20.00	100-11
Lakeshore Drive – with parking	2	4.00	N	N/A	N	N/A	2	2.40	12.80	N	N/A	2	2.00	N/A	N/A	2	3.60	20.00	100-11
Prairie Valley Road	2	3.50	N	N/A	N	N/A	N/A	N/A	10.00	N	N/A	2	2.00	2	1.50	2	5.00	20.00	100-10
Industrial	2	6.00	N	N/A	N	N/A	N/A	N/A	12.00	N	N/A	N/A	N/A	N/A	N/A	2	3.00	18.00	100-3
Lane (Centre Swale Drainage)	2	3.00	N	N/A	N	N/A	N/A	N/A	6.00	N	N/A	N/A	N/A	N/A	N/A	0	N/A	6.00	100-1
Lane (Cross Fall Drainage)	1	5.00	N	N/A	N	N/A	N/A	N/A	5.00	N	N/A	N/A	N/A	N/A	N/A	2	0.28	6.00	100-2
Urban Local	2	4.65	N	N/A	N	N/A	N/A	N/A	9.30	N	N/A	1	2.00	N/A	N/A	2	3.35	16.00	100-5
Rural Local	2	3.00	Y	1.00	Y	1.00	N/A	N/A	8.00	Y	4.00	N/A	N/A	N/A	N/A	2	4.00	16.00	100-4
Hillside Local – development both sides	2	3.0	N	N/A	N	N/A	2	2.40	6.00	N	N/A	1	1.5	N/A	N/A	2	4.0-4.8	14.80	100-9
Hillside Local – development on one side	2	3.0	N	N/A	N	N/A	1	2.40	6.00	N	N/A	1	1.5	N/A	N/A	2	4.0-4.8	14.80	100-9
Hillside Local – no development	2	3.0	N	N/A	N	N/A	N/A	N/A	6.00	N	N/A	1	1.65	N/A	N/A	2	3.0-4.0	13.00	100-9
Urban Collector Road (No Parking)	2	3.50	N	N/A	N	N/A	N/A	N/A	7.00	N	N/A	2	2.00	2	2.50	2	6.20	20.00	100-7
Urban Collector – Parking (both sides)	2	3.50	N	N/A	N	N/A	2	2.50	12.00	N	N/A	2	2.00	N/A	N/A	2	4.00	20.00	100-8
Urban Collector – Parking (parking one side)	2	3.50	N	N/A	N	N/A	1	2.50	9.50	N	N/A	2	1.80	2	2.50	2	5.00	20.00	100-8
Rural Collector	2	3.50	Y	0.5	Y	1.5	N	N/A	10.00	Y	varies	N/A	N/A	N/A	N/A	2	5.00	20.00	100-6

(1) Pavement width and parking varies as Parking Bays located approximately every 150m

**District of Summerland**  
**DESIGN STANDARDS**  
**5 – Roads**

**5.4. Alignments**

- (a) Alignment guidelines should be generally in accordance with the TAC Geometric Design Guidelines, except where superseded by regulating guidelines and/or the *District of Summerland*. Numerical guidelines are summarized in **Table 5.3**.

**5.4.1. Grade**

- (a) Normal limits are as shown in **Table 5.3**.
- (b) Use of the maximum grades shall be restricted to cases where:
- Desirable grade cannot be obtained due to topographical constraints
  - The geometric design of intersections can be improved by increasing grade on the minor street to avoid compromising design of the major street.
- (c) Maximum grades for through *roads* at intersections shall be reviewed in conjunction with the TAC Geometric Design Guide.

**5.4.2. Vertical Curves**

- (a) Vertical curve limits, as shown on **Table 5.3** are defined by the K-Value. This is the ratio of the curve length in metres to the algebraic difference in percent grades. Vertical curves shall be provided at the following grade changes:
- Greater than 2.0% for Locals and *Lanes*
  - Greater than 1.0% for Collectors
  - Greater than 0.5% for Arterials
- (b) Use of K-Values below the desirable limits shown in **Table 5.3** shall be restricted to cases justified by topographical constraints and subject to *Director* approval.

**Table 5.3 Alignment Standards**

Classification	Design Speed (km/h)	Max. Super-elevation (%) <sup>1</sup>	Min. Radius (m) <sup>2</sup>	Grade (%)		Crest	K-Value	
				Min	Max <sup>3,8</sup>		Sag <sup>8</sup>	
							No Illum.	Illum.
Walkway	--	--	--	0.5	12	--	--	--
Lane	--	--	--	0.5	9	7	11	6
Local	50	2	95 <sup>4</sup>	0.5	10	7	11	6
<i>Hillside</i> Local	40	4	45 <sup>9</sup>	0.5	12	4	--	4
Collector	60	6 4 <sup>2</sup>	160 <sup>4</sup> 140 <sup>5</sup> 130 <sup>6</sup>	0.5	9	15	60	10
Industrial	50	6 4 <sup>2</sup>	105 <sup>4</sup> 90 <sup>5</sup> 80 <sup>6</sup> 75 <sup>7</sup>	0.5	8	7	13	6

**5 – Roads**

---

1. Maximum super-elevation reduced to 4% where there are intersecting *roads* or private accesses.
  2. Minimum radii approaching intersections should be within the applicable decision sight distance range.
  3. Maximum grades approaching intersections vary by design speed, and should be referenced as per the TAC Geometric Design Guide.
  4. Normal crown.
  5. Reverse crown.
  6. 4% superelevation.
  7. 6% superelevation.
  8. To provide proper drainage, a maximum curve radius value of 80m for crest curves and 40m for sag curves shall be used.
  9. Hillside Standards are discussed in **Section 5.19**.
- (c) The designer shall consult with the fire department for applicable emergency access local standards

**5.4.3. Cross-Slopes**

- (a) Standard *roadways* shall have a centreline crown.
- (b) The generally accepted standard cross-slope is 2.0%. Minimum and maximum values vary by design speed between are 2.0% and 4.0%. In considering a minimum or maximum value, the safety implications shall be thoroughly investigated.
- (c) Under adverse topographic conditions, and with approval of the *Director*, offset crown or cross-fall may be used. The location of offset crowns shall be located on the *lane* line or the centre of the *lane*.
- (d) Upon approval by the *Director*, a centreline valley may be used for *lanes* and private *roads*.
- (e) Super-elevation introduction, transition, and usage shall follow guidelines within the BC Supplement to TAC Geometric Design Guide: Chapter 330 - Horizontal and Vertical Alignment and as shown in **Table 5.3**.

**5.4.3.1. Cross-Slope at Intersections**

- (a) At intersections, the cross fall of the minor street shall be varied to suit the profile of the major street. The maximum rate for changing cross fall at intersections is as follows:
  - Arterial: 3% in 30 m;
  - Collector: 4% in 30 m; and
  - Local: 6% in 15 m.



**District of Summerland**  
**DESIGN STANDARDS**  
**5 – Roads**

**5.5. Intersections****5.5.1. General**

- (a) The guidelines provided are general considerations for intersection design. The BC Supplement to TAC Geometric Design Guide and the TAC Geometric Design Guide (Chapter 2.3) shall be consulted for reference as part of the intersection design process.
- (b) Intersections shall be as close as possible to right angles. The maximum variation, subject to *Director* approval, is 20 degrees.
- (c) The minimum spacing between tee intersections is 60 m.
- (d) The minimum spacing between four-legged intersections on arterial streets is as required to provide a minimum 40 m of left turn storage (at both intersections), 35 m of transition between storage lanes and an allowance for turning movements.
- (e) Approach grades of minor streets at intersections to major streets shall not exceed 75 % of the maximum grade allowed for that street classification. The minor street shall be designed to intersect the major street with a vertical curve of minimum length required for that street classification. The vertical curve shall terminate at the curb line of the intersecting major street using the following K values:

**Table 5.4 Intersection Curves**

Intersecting Street	Minimum K Value	
	Crest Curve	Sag Curve
Local	4	4
Collector	7	6

**5.5.2. Curb Returns**

- (a) Minimum curb return radii are as follows in **Table 5.5**. The designer shall give due consideration to the design vehicles expected to utilize the intersections. Consult with BC Transit and the *District of Summerland* to confirm requirements. Consider the use of channelization to accommodate larger design vehicles and to provide appropriate pedestrian refuge.

**Table 5.5 Minimum Design Curb Return Radii (m)**

	Intersection with:		
	Local	Collector	Arterial
<i>Lanes</i>	3	With 3:1 flare to property corners	
Locals	7	9	11
Industrial	9	10	11
Collectors	9	10	10

**5.5.3. Corner Cuts**

- (a) Corner cuts shall be sufficient to provide a minimum 4 m distance from curb face to property line. Minimum corner cuts are as follows in **Table 5.6**:

**Table 5.6 Minimum Corner Cut Areas**

Intersection Type	Corner Cut
Collector and Local	5 m x 5 m
<i>Lane to Lane</i>	5.5 m x 5.5 m
Residential <i>Lane</i> to all other roads	Not required
Commercial/Industrial <i>lane</i> to any road	5 m x 5 m

**5.5.4. Left Turn Channelization**

- (a) Warrants for, and details of, left turn channelization are in accordance with the TAC Geometric Design Guide. Left turn bays shall be “opposing”.

**5.5.5. Sight Distances**

- (a) In addition to the sight distance limits shown elsewhere for vertical curves, intersection site distance must be provided for both the approach and the departure cases at an intersection. Design in accordance with the TAC Geometric Design Guide.

**5.5.6. Curb Extensions**

- (a) Curb extensions, also known as bulges or bulbs, shall be considered for speed reduction, reduced pedestrian crossing distance, and improved pedestrian visibility. Design in accordance with TAC – Canadian Guide to Neighbourhood Traffic Calming.

**5.5.7. Turn Delineation**

- (a) Guiding lines shall be used in intersections with multiple turn *lanes* or skewed legs.

**5.6. Roundabouts**

- (a) Roundabouts provide alternative design geometry to traditional intersections, and can be considered as an appropriate intersection treatment. They may be required by the *Director* in scenarios where signal operation is not possible, power access is a constraint, or there is a specific intent to remove the incident severity risk.
- (b) For all roundabout design considerations, the primary reference shall be the TAC Canadian Roundabout Design Guide.
- (c) Signs and pavement markings for roundabouts shall be in accordance with the B.C. MoT (Ministry of Transportation) – Manual of Standard Traffic Signs & Pavement Markings.
- (d) The locations of proposed Roundabouts within the *District of Summerland* will be determined by the *Director*.

**5.7. Railway Grade Crossings**

- (a) Locations and details of railway grade crossings are subject to requirements included in the TAC Geometric Design Guide and references noted therein.
- (b) Railway crossing signs shall be in accordance with B.C. MoT – Manual of Standard Traffic Signs & Pavement Markings.

**5.8. Traffic Control Devices**

- (a) Traffic control devices and signs and pavement markings shall be in accordance with B.C. MoT (Ministry of Transportation) – Manual of Standard Traffic Signs & Pavement Markings.

**5.9. Cul-De-Sac**

- (a) The maximum *road* length for a *cul-de-sac*, as measured from the edge of the intersecting through *road* to the centre of the *cul-de-sac* bulb, is 200 m. The allowable maximum length may be increased if alternate access for emergency and evacuation purposes are provided.

**Table 5.7 Cul-de-sac Alignment Standards**

	Minimum Grade (%)	Maximum Grade (%)
Cul-de-sac (entry downhill)	0.5	8
Cul-de-sac (entry uphill)	0.5	8
Cul-de-sac (bulbs)	0.5	6

- (b) Details shall be in accordance with the TAC Geometric Design Guide. Unless otherwise approved by the *Director*, turnaround areas are to be circular.

**5.10. Traffic Barriers**

- (a) Barriers shall be placed where warrants exist in accordance with the *Roadside Safety* section of the TAC Geometric Design Guide. Details should be as indicated in the guidelines.

**5.11. Sidewalk and Pedestrian Crossings**

- (a) Appropriate allocation of pedestrian facilities through sidewalk and pedestrian crossings is an important multi-modal consideration as part of the *roadway*.

**5.11.1. Sidewalk**

- (a) Sidewalk requirement varies by *road* class, and is outlined in **Table 5.2** above, Map A4 and the Sidewalks Master Plan.
- (b) Sidewalk locations may be adjacent to a curb or separated by a boulevard. Although design requirements are generally included herein, in the absence of specific local requirements, sidewalk details should be as follows:

## 5 – Roads

Design domain width:	2.0 m
Cross-slope:	2%, except at driveways and wheelchair ramps
Drainage:	Towards gutter

- (c) The incorporation of boulevards in the *road* design should be considered to enhance pedestrian safety. The width may vary based on *road* classification, speed, and utility requirements; however, **Table 5.2** provides average widths for different *road* classifications as a starting point.

### 5.11.2. Pedestrian Crossings

- (a) The warrant for pedestrian crossings must be considered as part of a broader analysis process which shall include an understanding of existing site conditions, pedestrian and traffic volumes, and pedestrian accessibility. This can be evaluated utilizing the Pedestrian Crossing Manual for British Columbia.
- (b) The pedestrian crossing width can range from a minimum of 2.5 m to as wide as 4.0 m. (TAC Design Guidelines, Section 2.3.14.1). The pavement marking and signage configuration for crossings shall be designed in accordance with the B.C. MoT (Ministry of Transportation) - Manual of Standard Traffic Signs & Pavement Markings.
- (c) Wheelchair ramps from sidewalks, medians and traffic islands to crosswalks shall be provided at intersections and multi-use pathways. Locations and details of ramps and related pedestrian safety features shall be in accordance with the standard drawings, the Sidewalks Master Plan and the TAC Geometric Design Guide.
- (d) Sidewalks, crosswalks, and pedestrian facilities should be designed in accordance with the following guidelines:
- TAC Geometric Design Guide, 1999 (Section 2.2.6, Section 2.3.14, Section 3.3);
  - TAC – Pedestrian Crossing Control Manual, 2012;
  - BC MOTI – British Columbia Active Transportation Design Guide;
  - Pedestrian Crossing Control Manual for British Columbia, Second Edition, 1994; and
  - BC Ministry of Transportation – Manual of Standard Traffic Signs & Pavement Markings

### 5.12. Cycling Facilities

- (a) Cycling facilities provide appropriate access in different conditions and *road* classes for bicycles users. Unique guidelines must be incorporated when considering cyclists as part of a *road* design to ensure the safety and comfort of all *road* users.
- (b) Cycling facilities are classified into the following on street and off-street classifications:

#### 5.12.1. On Street Cycling Facilities

- (a) **Primary AAA (On-Street) routes** can include infrastructure such as protected bicycle *lanes*, bicycle boulevards, and buffered bicycle *lanes*. These types of infrastructure tend to be the most effective at increasing ridership as they are most preferred by users and are proven to be safest types of facilities. Primary On-Street routes are proposed within the downtown and on

---

**5 – Roads**

---

major *roadways* connecting neighbourhoods. Below is description of the different infrastructure types that are suitable for Primary AAA routes:

- **Protected bicycle lanes** are physically separated from motor vehicle travel *lanes* but are located on-street within the *roadway* surface. Protected bicycle *lanes* combine the benefits of increased comfort offered by off-street pathways due to their separation from motor vehicle traffic, with the benefits of route directness provided by on-street facilities. They also provide separation between people walking and people cycling. There are many types of protected bicycle *lanes*, offering varying types of treatments to provide protection. Types of separation include concrete barriers, elevation, bollards, parked cars, visual surface treatments such as pavers, and painted buffers. Protected bicycle *lanes* are usually installed in locations with high cycling demand and potential, such as within town centres or routes that provide direct connections to important destinations. They are often located on streets where motor vehicle volumes and speeds are higher.
  - **Bicycle boulevards** are bicycle routes located on streets with low traffic volumes and speeds. These streets have been optimized to varying degrees to prioritize bicycle traffic. Bicycle Boulevards are often found on low volume streets that run parallel to major *roads* or within neighbourhoods on residential streets connecting existing trails and pathways. Bicycles and motor vehicles share the *roadway*. In cases where the existing streets have relatively low traffic volumes and speeds, the only improvements required may be signage and pavement markings identifying the *road* as a bicycle route, and enhancements to crossings where the bicycle boulevard intersects with major *roads*. However, they can and should be further enhanced with traffic calming measures such as traffic circles and traffic diverters if volumes and speeds are high.
  - **Buffered bicycle lanes** are conventional bicycle *lanes* (described below) that have a painted buffer. The painted buffer can be located between the bicycle and motor vehicle *lanes* or between the bicycle *lane* and parked vehicles. Buffered bicycle *lanes* are more comfortable than conventional painted bicycle *lanes* as there is spatial separation between people cycling and adjacent traffic *lanes*. Buffered bicycle *lanes* are distinguished from protected bicycle *lanes*, as the former do not provide a physical barrier, such as bollards, curbs, or planters.
- (b) **Secondary Routes** are typically not considered to be AAA and are considered part of the supporting network. Secondary Routes can include infrastructure such as, painted bicycle *lanes*, shoulder bikeways and shared use *lanes*.
- **Painted bicycle lanes** are designated exclusively for bicycle travel. Bicycle *lanes* help to define the *road* space for bicyclists and motorists. Bicycle *lanes* are generally suitable on streets with moderate traffic volumes.
  - **Shoulder bikeways** can be used in *rural* areas to provide a dedicated space for people cycling on *rural roads* and *highways*, they are located on streets without a curb.
  - **Shared use lanes** using 'sharrow' pavement markings indicate a shared space for bicycles and other vehicles.

- An **Advisory Bicycle Lane** is bicycle-priority travel *lane* on a narrow *road* with a single, narrow centre travel *lane* for motor vehicles that accommodates two-way vehicle traffic but that may require one motorist to pull to the side of the *road* to allow the other to pass.

### 5.12.2. Off Street Cycling Facilities

- (a) **Off-Street Pathways** are typically considered an AAA facility. They are physically separated from motor vehicles by an open space or a barrier, depending on the application. Off-street pathways can provide enough width to be used by a variety of users including, people walking, cycling, and other forms of active transportation like inline skating and joggers. Off-street pathways can have paved or unpaved surfaces. Paved or firm surfaces are often preferable for people cycling and people with mobility aids or strollers. Off-street pathways are an effective facility where right-of-way is available. They can be installed parallel to a major *roadway*, within a park or along a utility corridor. A bike path or multiuse pathway is physically separated from the *roadway* and sometimes shared with recreational users.
- (b) The lane width design domain for each of these facilities can be considered as per **Table 5.8** below.

**Table 5.8 Bicycle Facility Lane Width Design Domain**

Bike Facility Type	Design Domain for Lane Width <sup>1</sup> (m)
Protected Bicycle <i>Lanes</i> (unidirectional)	2.5 <sup>2</sup>
Protected Bicycle <i>Lanes</i> (bidirectional)	4.0
Buffered Bicycle <i>lanes</i>	1.8 <sup>3</sup>
Painted Bicycle <i>Lanes</i>	1.8
Shoulder bikeways	1.8 – 3.0 <sup>4</sup>
Shared use <i>lanes</i>	4.3
Bike Path	3.0 - 4.0

1. Width varies based on vehicle volume, speed, and percentage of commercial vehicle volume.
2. If street buffer *zone* is not adjacent to on-street motor vehicle parking the desirable buffer width is  $\geq 0.9\text{m}$ , with a wider buffer creating additional cycling comfort.
3. Painted buffer width is 0.6m.
4. *Lane* widths vary based on speeds, with 1.8m for  $\leq 50\text{ km/h}$ , 2.5m for  $< 70\text{ km/h}$  and 3.0 m for speeds  $\geq 70\text{ km/h}$ .

- (c) All cycling facilities shall be designed in accordance with the following guidelines:
- BC MOTI – British Columbia Active Transportation Design Guide;
  - TAC Geometric Design Guide; and
  - TAC - Bikeway Traffic Control Guidelines for Canada.

### 5.13. Transit Facilities

- (a) The requirement for transit facilities will be established by the *Director*.

- (b) With respect to geometry, there are specific *lane* width implications for transit design vehicles which should be considered by the designer. Transit design vehicles vary and should be confirmed prior to embarking on the design process. As per the TransLink Transit Infrastructure Design Guidelines, **Table 5.9** below outlines the desired curb *lane* width in specific scenarios:

**Table 5.9 Desirable Transit Vehicle Lane Width Requirements**

Through Lane Scenario	Desired Lane Width
Three through <i>lanes</i> with no parking	3.3 m to 3.7 m
One through <i>lane</i> , One shared/parking <i>lane</i>	5.8 m for shared/parking <i>lane</i>
One shared/parking <i>lane</i> only	6.5 m
Single Travel <i>Lane</i>	4.8 m maximum

- (c) In all cases where transit vehicles are intended to be accommodated, appropriate turning radii, gradients, and sight distances shall be incorporated. The reference guidelines identified below provide guidance in selecting the appropriate design values. All designs shall be approved by the appropriate local transit authority.
- (d) Geometric design shall also consider the implications on transit users, specifically addressing accessibility constraints at bus stop locations. The TransLink Universally Accessible Bus Stop Design Guidelines can be referenced.
- (e) Transit signs shall be in accordance with the BC Manual of Uniform Traffic Control Devices in addition to any unique signage required by the local transit authority.
- (f) Bus bay locations shall be established in cooperation with the local transit authority. Bus bay details shall be in accordance with local design guidelines in addition to the Pullouts section of the TAC Geometric Design Guidelines.
- (g) Additional guidelines are included in:
- BC Transit - Infrastructure Design Guidelines, 2010;
  - TransLink - Transit Infrastructure Design Guidelines, 2002;
  - TransLink - Universally Accessible Bus Stop Design Guidelines, 2007;
  - TransLink – Transit Service Guidelines, 2004; and
  - Canadian Urban Transit Association and TAC – Canadian Transit Handbook, 1993.

#### 5.14. Driveways

- (a) Driveway requirements are located within the *District of Summerland's* Driveway Access Bylaw No. 92-047.

#### 5.15. Clearances

##### 5.15.1. Clearance at Bridges

- (a) Horizontal clearances in metres from edge of travel *lane* should be designed in accordance with the TAC Geometric Design Guide Section 2.2.10.

### 5.15.2. Aerial Utilities

**Table 5.10 Aerial Utility Vertical Clearances**

Type	Vertical Clearance
Communications and guy wires	5.0 m
Electrical conductors to 90,000V	5.5 m

### 5.15.3. Signs and Poles

- (a) Horizontal clearance from edge of travel *lane* to edge of power pole or sign:
- *Roadways* without curbs: 2.0 m; and
  - *Roadways* with curbs: 0.3 m minimum. 1.0 m preferable except where sidewalk is adjacent to curb, in which case 1.6 m is preferable.
- (b) These guidelines assume design speeds of 60 km/h and below. For higher speed *roads*, refer to Section 620 of the BC Supplement to TAC Geometric Design Guide.
- (c) Use of minimum clearance should be justified by safety appurtenances such as poles with break-away or frangible bases or sign poles of light weight fabrication.
- (d) Horizontal clearance to lighting and signal poles and signal controller cabinets in accordance with **Section 6.0, Roadway Lighting** and **Section 7.0, Traffic Signals** of this Bylaw.

### 5.15.4. Trees

- (a) Minimum horizontal clearance from edge of travel *lane* to tree trunk:
- *Roadways* without curbs: 2.0 m
  - *Roadways* with curbs: 0.75 m Horizontal clearance from edge of driveway, curb return or above ground utility to tree trunk: 2.5 m.

### 5.15.5. Drainage Structures and Traffic Barriers

- (a) Clearances in accordance with the *Roadside Safety* section of TAC Geometric Design Guidelines and the BC Supplement to TAC Geometric Design Guidelines.

## 5.16. Underground Utility Locations

- (a) Underground utility locations within a *road* right-of-way will vary with the *road* cross section. General guidelines include the following:
- Manholes and valve boxes clear of wheel paths;
  - All utilities clear of curbs;
  - Sanitary sewers at pavement centre line;
  - Storm sewer 3.0 m from edge of sanitary sewer;
  - Water mains 3.0 m from edge of sanitary sewer and 3.0 m from edge of storm sewer; and



- Electrical, telephone and gas in boulevard or under sidewalk.

### 5.17. Pavement Structures

#### 5.17.1. General

- (a) The structural design of pavements for *roads* shall be performed by a qualified pavements Engineer. Structural designs of pavements shall be submitted to the *Director* in an acceptable report format.
- (b) Pavement design should be based on one of the following methods:
  - Past history of successful pavements in adjacent similar areas.
  - Any design method covered in the TAC – Pavement Design and Management Guide.
- (c) Pavement design is to include consideration of the subgrade soil type, frost susceptibility, moisture conditions, subgrade drainage provisions and anticipated traffic conditions.
- (d) Minimum design life for all classifications of *roads*: 20 years.

#### 5.17.2. Pavement Design

- (a) Subgrade Soil Classification
- (b) Soils are characterized according to the Unified Soil Classification System (USCS) which uses symbols such as GW to classify soils according to particle sizes and distribution and plasticities. Details of USCS are contained in the TAC - Pavement Design and Management Guide and other publications.
- (c) Frost Susceptible Areas
- (d) For areas of frost susceptibility where the subgrade soil classifications are GM, GC, SM, SC, ML, CL, or OL, the pavement structure should include granular material to the minimum depth as defined below:

**Table 5.11 Minimum Frost Protection Depth %**

Classification	Minimum Frost Protection Depth as % of Frost Penetration
Local	20%
Collector	35%

Where the minimum frost protection depth exceeds the minimum pavement structure depth, granular material having a fines content of less than 12% should be placed below the pavement structure to make up the difference.

- (e) Traffic and Load Data

## 5 – Roads

- (i.) Traffic conditions include traffic volume and vehicle classification counts. The traffic evaluation methods presented in the TAC - Pavement Design and Management Guide using Annual Average Daily Traffic (AADT) showing various truck type percentages with equivalent truck factors, traffic growth, traffic directional split and *lane* distribution for the design *lane* shall be used. The traffic loading is expressed as an Equivalent Single Axle Load (ESAL)(80kN), which will accumulate during a 20-year design period.
- (ii.) Minimum ESAL's are indicated in **Table 5.12**:

**Table 5.12 Minimum ESAL's**

Classification	Design Traffic (I) (ESAL's)
Local	2.8x10 <sup>4</sup>
Collector	2.8x10 <sup>5</sup>
Industrial	2.8x10 <sup>5</sup>

## (f) Pavement Structural Adequacy

- (i.) Pavement structural adequacy is commonly measured with a Benkelman Beam or a Falling Weight Deflectometer (FWD) (See TAC - Pavement Design and Management Guide.)
- (ii.) Maximum Benkelman Beam deflections (mean plus two standard deviations) are set as an upper limit for the design of new *roads* and overlays, and for confirming acceptability of *constructed roads*. FWD deflection data can be converted to equivalent Benkelman Beam data according to the Asphalt Institute "Asphalt Overlays for *Highway* and Street Rehabilitation", MS-17.
- (iii.) Maximum Benkelman Beam deflections are as follows:
- Local: 1.5 mm
  - Collector: 1.25 mm
  - *Industrial*: As specified by the *Director*

## (g) Asphalt Mix Design

- (i.) Asphalt Mix Design shall be specified to be carried out by a laboratory which is certified by Canadian Council of Independent Laboratories (CCIL) for Marshall and/or Superpave Mix Design testing (Type "A" Certification).

**5.17.3. Pavement Alternatives**

- (a) Two basic pavements types, flexible and rigid, are defined by their structural function or response. Alternative pavement designs providing economical and environmental friendly strategies are discussed in alternative design manuals.
- (b) Minimum pavement Structures

## 5 – Roads

- (i.) Regardless of the method used for pavement structure design, pavement component thicknesses should be equal to or greater than the minimum thicknesses shown below.
- (ii.) Minimum pavement structures shown below are based on the subgrade soil classifications indicated.
- (iii.) Subgrade soils having classifications of MH, CH, OH and Pt require special treatment or removal and replacement with soil having better strength and drainage characteristics.

**Table 5.13 Minimum Pavement Structure for Asphaltic Concrete (A.C.) Pavement**

Road Classification	3.0 ≤ CBR ≤ 6.0			
	Granular Sub-base (mm)	Crushed Granular Base Course (mm)	Hot Mix Asphalt (mm)	
			Surface Course	Base Course
Walkway	150	50	50	--
Lane	300	75	50	--
Local	300	100	50	--
Industrial	300	100	38	38
Collector	300	100	38	38

- (c) Minimum Asphaltic Concrete Pavement Overlay
  - (i.) The design of structural overlays of existing pavements shall be based on the analysis of the results of Benkelman beam tests and test hole information acquired from the existing *road* which is to be upgraded.
  - (ii.) The Transportation Association of Canada procedure for designing structural design of overlays of existing pavements, as published in "The Pavement Management Guide", shall be used. The maximum permissible Benkelman beam deflections are listed above in **5.17.2 – Pavement Design**.
  - (iii.) Where existing pavements are to be overlaid, the minimum overlay thickness is three times the maximum nominal aggregate size, but in no case less than the following:

**Table 5.14 Minimum Pavement Structure for Asphaltic Concrete (A.C.) Pavement**

Classification	Minimum Asphaltic Concrete Overlay Thickness (mm)
Local	30
Industrial	40
Collector	40

- (d) Minimum Structures for Sidewalk, Walkways and Driveways

**Table 5.15 Asphaltic Concrete**

## 5 – Roads

Item	Granular Sub-base (mm)	Crushed Granular Base Course (mm)	Hot Mix Asphalt Surface Course (mm)
Walkway	150	50	50
Driveway	150	50	50
Emergency Access	150	75	50

Table 5.16 Portland Cement (P.C.) Concrete

Item	Granular Sub-base (mm)	Crushed Granular Base Course (mm)	Portland Cement Concrete (mm)
Sidewalk	150	50	100
Walkway	150	50	100
Residential Driveway	150	50	100
Industrial/Commercial Driveway	150	50	200
Sidewalk Crossing	150	50	150

## 5.18. Bridges

- (a) Bridges, including culvert structures that span larger than 3.0 m, are to be designed in accordance with the Canadian Highway Bridge Design Code CAN/CSA S6 and the BC MOTI Supplement to Canadian Highway Bridge Design Code. The *District of Summerland* will set the design criteria for each structure at the onset of design.
- (b) Roadway bridges shall be designed to a minimum loading of CL 625.

## 5.19. Hillside Standards

- (a) In steep slope areas (*Hillside Areas* as outlined on **Map A.2**) where it is challenging to conform to the above guidelines, the *Director* may allow the above to be modified for *hillside* neighbourhoods.
- (b) The design objective of *hillside* standards includes the following:
- Accommodation of *hillside* land development while minimizing environmental impacts such as disturbance of natural slopes, vegetation, and watercourses;
  - Encouragement of low-speed traffic, particularly for local roads; and
  - Development of site layouts compatible with the above objectives.
- (c) Before agreeing to vary any part of this bylaw, the *Director* must be satisfied that the variance is warranted due to the topographical constraint involved and the varied criteria is presented and acceptable as good engineering practice, environmentally sound, and does not adversely affect transportation or public safety.
- (d) Steep slopes are defined as lands in their natural state that have a slope angle exceeding 20% or greater for a minimum horizontal distance of 10 meters, or adjacent areas where existing or potential sloughing or stability warrants concern. The definition applies to all properties which

## 5 – Roads

are 0.5 hectares or greater in size, and where 10% or greater of the parent property contains slope of more than 20%.

- (e) Slopes of greater than 30% may require special consideration.

#### 5.19.1. Pre-Design Report

- (a) The *Consulting Engineer* is to use innovative design techniques to minimize impacts to future landowners, and limit maintenance to the *District of Summerland*. The *Consulting Engineer*
- (b) shall also limit impacts to sensitive steep slopes and natural drainage areas.
- (c) The *Consulting Engineer* is expected to minimize the total amount of cut and or fill and its environment and visual impact when designing and developing a *hillside* area.
- (d) Detailed geotechnical, slope stability, hazard assessments and hydrogeological reports shall be required as part of the pre-design report and shall be submitted prior to approval of a *Subdivision or Development*. The pre-design report for *hillside* areas will also have to address and provide recommendations for:
- (i.) Slope Stability concerns. The *Director* may require a more intensive investigation than outlined in this section.
  - (ii.) A *lot* grading and drainage management plan that mitigates the potential impacts onsite and downstream. The drainage management plan shall include at a minimum the following:
    - Existing and proposed topography.
    - Key cross sections showing cuts and fills related to building sites, *roads*, and retaining walls.
    - Erosion and sedimentation control and protection.
    - Pre and post *development* hydrogeological conditions.
    - Stormwater quality and treatment.
    - Protection of natural drainage patterns or water course.
    - Drainage control around future buildings and between upper and lower *lots*.
    - Control and discharge of roof and footing drainage.
  - (iii.) Underground infrastructure pipe bedding, trench backfill and mechanical restraints.
  - (iv.) Water pressure for fire fighting to highest side of *lot* and/or suitable pressure for top floor sprinklers
  - (v.) Rockfall hazards.
  - (vi.) *Roadwork* structure, tack coat requirements and guard rail requirements.
  - (vii.) Driveway access concerns.
  - (viii.) Building code structural or foundation requirements.
  - (ix.) Restrictions on irrigation and removal of vegetation.
  - (x.) Environmental impact assessment.
  - (xi.) Assessment of upgradient and downgradient conditions.
  - (xii.) A list of requirements on a *lot-by-lot* basis pertaining to covenants that may be required.
  - (xiii.) Land Clearing and Tree Retention and Removal plans.

**5 – Roads**

---

- (xiv.) Urban Wildfire Protection Plan.
- (e) Each *Parcel* created by *Subdivision* must have a buildable site with a building envelope, setbacks and driveways shown on the conceptual drawing.

**5.19.2. Hillside Emergency Access**

- (a) Guidelines for emergency access *roads* at long culs-de-sac include the following:
  - (i.) Maximum grade: 15%;
  - (ii.) Minimum right-of-way and *roadway* width: 4.5 m;
  - (iii.) Removable bollards or swing gates, at the discretion of the *Director*, to prevent access by non-emergency vehicles;
  - (iv.) Pavement structure equivalent to local *road*; and
  - (v.) Shared use with pedestrian walkway or bikeway.

**5.19.3. Cross-section Elements**

- (a) *Hillside Road* cross-section element guidelines are shown above in **Table 5.2**.

**5.19.4. Alignments**

- (a) *Hillside road* alignment guidelines are shown above in **Table 5.3**.
- (b) Note that the combination of minimum radius and maximum gradient shall be avoided.

**5.19.5. Road Lane Grade Separation (Split-Road Section)**

- (a) Cross-sectional separated grade (one way) *lanes* are a design option to minimize excessive cut/fill slopes, protection of large trees, improve property access or allowance for gravity sewer connections for down slope *lots* to the street.
- (b) Center median cross-section slopes shall be protected from erosion and designed to be maintenance free.
- (c) Utility offsets shall be established within the down slope *road* section with storm mains and sanitary mains in common trench.

**5.19.6. Intersection Grades/Site Clearances**

- (a) Through street maximum grade is 8%. The *Director* may consider increases due to topographic constraints. Cut/fill slopes, vegetation planting, retaining wall structures and parking, shall be designed to provide all required sight distances.

**5.20. Traffic Calming**

- (a) The requirements for Traffic Calming shall be at the discretion of the *Director*, and the specific approach for traffic calming shall be in accordance with the TAC - Canadian Guide to Neighbourhood Traffic Calming. In all cases, the physical traffic calming design shall be

## 5 – Roads

accompanied by an appropriate network plan for design vehicle usage of different *roadways* within the neighbourhood area.

- (b) While detailed consideration of specific devices is required prior to their implementation, **Table 5.14** provides a list and description of some of the commonly used treatments for Traffic Calming.

**Table 5.14 Summary of Commonly Used Treatments for Traffic Calming**

Treatment	Description
Raised Crosswalks	A pedestrian crosswalk <i>constructed</i> at a higher elevation than the adjacent <i>roadway</i> . This may be located at a mid-block location or an intersection.
Raised Intersections	An intersection <i>constructed</i> at a higher elevation than the adjacent <i>roadway</i> , including crosswalks.
Speed Humps	A raised area of <i>roadway</i> meant to slow the speed of through traffic.
Textured Pavement	Pavement with specific textured or pattern surface to differentiate it from the adjacent <i>roadway</i> .
Chicane	A series of alternating curb extensions which narrow the <i>roadway</i> and require vehicles to steer from one side of the <i>roadway</i> to the other to slow through traffic.
Curb Extensions	A horizontal intrusion of the curb into the <i>road</i> to create a narrow section of <i>roadway</i> at a particular location.
Curb Radius Reduction	The reconstruction of an intersection corner using a smaller curb radius.
On Street Parking	Reduction of overall <i>roadway</i> width using permitted on street parking to slow the movement of through traffic.
Traffic Circle	Different from a roundabout, this does not change the alignment of approaching vehicles, but forces a circular movement around the intersection by introducing a central circular island.

### 5.21. Street Parking

- (a) The design of appropriate street parking geometry enables access of the surrounding area, while maintaining the appropriate traffic throughput of the *road* designation. The designer shall consider *District of Summerland* regulations for guidance on appropriate street parking allocation.
- (b) In the absence of applicable guidelines, **Table 5.15** can be considered below in conjunction with the TAC Geometric Design Guidelines.

**Table 5.15 Street Parking Width Design Domain**

Road Classification	Street Parking Width Design Domain
Local Road (50 km/h)	2.4 m
Minor Collector (60 km/h)	Permanent: 2.4 m
Major Collector (70 km/h)	Not Recommended

- (c) In addition to street parking width, the designer shall consider the appropriate restriction of parking adjacent to intersections. The *District of Summerland's Traffic and Use of Highways Bylaw* shall be taken as the primary guideline for this purpose. In the absence of applicable guidelines, the designer shall consider the design vehicle turning radius and sight distances at intersections and use an appropriate set back of parking restrictions to enable these vehicles to move safely through.

## 5.22. Retaining Wall Systems and Alterations

### 5.22.1. General

- (a) These guidelines are not intended to be a substitute for sound engineering knowledge and experience. *Road* designs shall be prepared under the direction of design professional who has the appropriate experience and is registered with Engineers and Geoscientists of British Columbia.
- (b) All wall designs shall be in accordance with EGBC's Retaining Wall Design Professional Practice Guidelines and the *District's Zoning Bylaw No. 1726*.
- (c) Retaining walls must not exceed 2.0 m in height.

### 5.22.2. Conditions Requiring Retention

- (a) Retention of land shall be required in the following conditions:
- (i.) Where it is deemed necessary, by the *Director* to provide stability to existing or altered slopes or to control potential erosion;
  - (ii.) Where the slopes either existing or altered are steeper than their natural geological angle of repose or steeper than 2 horizontal to 1 vertical whether terraced or otherwise;
  - (iii.) Where it is deemed necessary to protect *Works and Services* or provide access to *Works and Services*;
  - (iv.) Where it is deemed necessary to retain other land or structures; and
  - (v.) Where it is deemed necessary to control surface drainage by altering the contours of the land.

### 5.22.3. Design and Inspection

- (a) The design and inspection of any retention system or structure shall be prepared and carried out by the *Consulting Engineer* who shall be responsible to acquire geotechnical consultation and advice where conditions present the need for it.
- (b) Consideration shall be given to the aesthetic appearance of retention structures. Where practical, retaining walls shall be rock gravity walls designed to be consistent with the natural surroundings of the area. The following types of structures shall not be permitted as permanent structures:
- (i.) LOCK BLOCKS (concrete blocks approximately 750mm x 750mm x 1,500mm) unless:



## 5 – Roads

- No more than one half of the top course of blocks are exposed with the top surface being flat without locking stubs;
  - Ends of the system include sloping transition blocks where topography is sloping;
  - Exposed faces and surfaces, including the top surfaces of such system, are faced, or surfaced with either exposed aggregate or granite finish;
  - Continuous reinforced concrete footings are installed; and
  - Geogrid reinforcing is installed between each horizontal row of blocks.
- (ii.) GABION (wire baskets filled with rocks) except for in-stream or waterfront erosion protection, not more than two (2) baskets high.
- (iii.) WOOD CRIB (over one (1) metre high or terraced at a slope steeper than (2) horizontal to one (1) vertical).

**5.22.4. Guardrails or Fences**

- (a) Guardrails or fences shall be required at the top of retention structure where the difference in elevation between adjacent levels exceeds 1 m.
- (b) Landscaping alternatives may be used providing it is of a dense thorny type to discourage access to the top of the retention structure area and providing the difference in elevation between adjacent levels does not exceed 1.5 metres.

**5.22.5. Building Permits for Retention Structures**

- (a) *Building Permits* are required for all retention structures which are more than 1m high and/or terraced at a slope steeper than 2 horizontal to 1 vertical.
- (b) *Building Permit Applications* shall be accompanied by the following documentation signed and sealed by the *Consulting Engineer*:
- Scaled structural, geotechnical and drainage details;
  - Scaled site plan showing the location of the retention structures in relation to any property lines. Rights-of-way or easements, tanks, other structures, underground works or services or natural features and confirmed by a *Surveyor* if deemed necessary; and
  - Letters of Assurance of Design and Field Review.

**5.22.6. Completion of Retention Works**

- (a) The *Owner* shall take all necessary measures, temporary and permanent to provide any necessary protection.
- (b) All required retention works are required to be completed prior to:
- Substantial Completion of a *subdivision*; or
  - Occupancy of a building in a *Development*.
- (c) If an extension of time is necessary, the *Owner* shall provide to the *District*:
- A security deposit in an amount equal to the cost of the outstanding work; and
  - An agreed upon time schedule to complete the work.

- (d) The *Building Official* may withhold occupancy of any *Building Permit* if the incomplete works present a safety hazard or are not secured by a deposit and accompanying schedule as described above.
- (e) Retaining walls will not normally be permitted within utility rights-of-way

<b>6. Roadway Lighting.....</b>	<b>98</b>
6.1. General.....	98
6.2. Codes, Rules, Standards and Permits .....	98
6.3. Light Sources and Luminaires.....	99
6.4. Street Lighting.....	99
6.5. Sidewalk Lighting .....	100
6.6. Intersection Lighting.....	101
6.7. Crosswalk Lighting.....	101
6.8. Walkways.....	102
6.9. Roundabout Lighting.....	102
6.10. Tunnel Lighting .....	102
6.11. Poles.....	102
6.12. Pole Foundations .....	103
6.13. Luminaires .....	103
6.14. Power Supply and Distribution .....	104
6.15. Design .....	105

**6. Roadway Lighting**

**6.1. General**

- (a) Street lighting (also referred to as *roadway lighting*) generally refers to lighting of streets and *roadways* including sidewalks, crosswalks, intersections, roundabouts, walkways and tunnels, The principal purpose of street lighting is to enhance visibility at night. For a pedestrian, street lighting improves visibility of the surrounds and the sidewalk, while for the driver of a motor vehicle it increases visibility resulting in more time to stop or to maneuver around an obstacle. Good lighting has been shown to significantly reduce night-time collisions specifically on urban streets, urban and *rural* intersections, roundabouts, and mid-block crosswalks.
- (b) This document is intended to provide some basic lighting and electrical criteria and guidelines to aid in the design of street lighting. Further information shall be obtained from the most current edition of the Transportation Association of Canada (TAC) Guide for the Design of *Roadway Lighting*. Those undertaking street lighting designs must be knowledgeable of all parts of the TAC Guide.
- (c) These design guidelines are not intended to be a substitute for sound engineering knowledge and experience in street lighting design and the Canadian Electrical Code. *Roadway* lighting design shall be prepared under the direction of a design professional registered with the Association of *Professional Engineers* and Geoscientists of British Columbia (EGBC).

**6.2. Codes, Rules, Standards and Permits**

Street lighting systems shall be designed in general conformance with the following:

**6.2.1. Codes, Rules and Regulations**

- Canadian Electrical Code, latest edition, and bulletins issued by Electrical Safety Branch of the Province of British Columbia;

- American Association of State Highway and Transportation Officials (AASHTO) Standard Specifications for Structural Supports for Highway Signs, Luminaires and Traffic Signals or CAN/CSA-S6-00 Canadian Highway Bridge Design Code;
- WorkSafeBC;
- Canadian Standards Association (CSA);
- Summerland Electric Utility regulations; and
- Regulations issued by municipal, provincial, and federal authorities.

**6.2.2. Standards and Guidelines**

- TAC – Guide for the Design of *Roadway* Lighting;
- Canadian Standards Association (CSA);
- *MMCD* Standard Specifications and Drawings, plus Supplementary Specifications and Drawings.
- Summerland Electric Utility standards; and
- *District of Summerland* Approved Products List.

**6.2.3. Permits**

- Electrical Permits as required by provincial or municipal inspection authorities; and
- Right-of-way and utility crossing permits for crossing of electrical transmission lines, railways, *highways*, and regional, provincial, and federally regulated pipelines.

**6.3. Light Sources and Luminaires**

- (a) Light sources shall be LED and the luminaires shall be from the *District of Summerland's* Approved Products List.

**6.4. Street Lighting**

- (a) Street lighting levels for various street types and night-time pedestrian activity levels are defined in the Luminance Table below. This table is based on information listed in the Transportation Association of Canada Guide for the Design of *Roadway* Lighting.

**Table 6.1 Luminance Table**

Street Type	Pedestrian Activity	Average Luminance (cd/m <sup>2</sup> )	Average-to-Minimum Uniformity Ratio	Maximum-to-Minimum Uniformity Ratio	Maximum-to-Average Veiling Luminance Ratio
<b>Collector</b>	High	≥ 0.8	≤ 3.0	≤ 5.0	≤ 0.4
	Medium	≥ 0.6	≤ 3.5	≤ 6.0	≤ 0.4
	Low	≥ 0.4	≤ 4.0	≤ 4.0	≤ 0.4
<b>Local/Alley</b>	High	≥ 0.6	≤ 6.0	≤ 10.0	≤ 0.4
	Medium	≥ 0.5	≤ 6.0	≤ 10.0	≤ 0.4
	Low	≥ 0.3	≤ 6.0	≤ 10.0	≤ 0.4

- (b) When undertaking lighting calculations on single- or two-*lane* roadways the maximum *lane* width used in the calculation shall be 4m. When scenarios are encountered where the *lane* is over 4m, a 4m wide *lane* shall be applied from the travel portion of the *roadway* (i.e.; centerline for 2 *lane* road). This scenario will be most common for residential *subdivisions*.

- (c) Where part-time parking *lanes* exist or are proposed they shall be calculated as if they are full-time general-purpose *lanes*. Full time on-street angled or parallel parking, where there is no chance the parking will be used as a travel *lane*, shall not be included in the lighting calculations.
- (d) Luminance calculations are not practical on curved and steep grade *roadways*. Lighting for curved street sections (less than a 600m radius) and steep grades (6% or greater) shall be calculated using the Horizontal Illuminance Table below. For the calculations, 2m grids shall be placed across the travel *lanes*.

**Table 6.2 Horizontal Illuminance Table**

Street Type	Pedestrian Activity	Pavement Classification			Average to Minimum Uniformity Ratio	Maximum to Average Veiling Luminance Ratio
		R1 (lux)	R2/R3 (lux)	R4 (lux)		
Collector	High	≥ 8.0	≥ 12.0	≥ 10.0	≤ 4.0	≤ 4.0
	Medium	≥ 6.0	≥ 9.0	≥ 8.0	≤ 4.0	≤ 4.0
	Low	≥ 4.0	≥ 6.0	≥ 5.0	≤ 4.0	≤ 4.0
Local/Alley	High	≥ 6.0	≥ 9.0	≥ 8.0	≤ 6.0	≤ 4.0
	Medium	≥ 5.0	≥ 7.0	≥ 6.0	≤ 6.0	≤ 4.0
	Low	≥ 3.0	≥ 4.0	≥ 4.0	≤ 6.0	≤ 4.0

- (e) Use R2/R3 pavement classification for typical asphalt streets. For a definition of other pavement classifications refer to the Transportation Association of Canada Guide for the Design of *Roadway Lighting*.

**6.5. Sidewalk Lighting**

- (a) Sidewalk lighting levels for various pedestrian activity levels are defined in **Table 6.3**, Sidewalk Illuminance Table below. This table is based on information listed in the Transportation Association of Canada Guide for the Design of *Roadway Lighting*. Refer to the TAC Guide for grid set-up and spacing.

**Table 6.3 Sidewalk Illuminance Table**

Pedestrian Activity	Maintained Average Horizontal Illuminance (lux)	Average-to-Minimum Horizontal Uniformity Ratio	Minimum Maintained Vertical Illuminance (lux) - Desired but not Mandatory
High	≥ 20.0	≤ 4.0	≥ 10.0
Medium	≥ 5.0	≤ 4.0	≥ 2.0
Low	≥ 3.0	≤ 6.0	≥ 0.8

**6.6. Intersection Lighting**

- (a) Intersection lighting levels for various street types and pedestrian activity levels are defined in the Intersection Horizontal Illuminance **Table 6.4** below. This table is based on information tabulated in the Transportation Association of Canada Guide for the Design of *Roadway Lighting*.

**Table 6.4 Intersection Horizontal Illuminance Table**

Roadway Classification	Average Maintained Horizontal Illuminance (Lux) at Pedestrian Activity Levels			Average-to-Minimum Uniformity Ratio
	High	Medium	Low	
Collector/Collector	≥ 24.0	≥ 18.0	≥ 12.0	≤ 4.0
Collector/Local	≥ 21.0	≥ 16.0	≥ 10.0	≤ 4.0
Local/Local	≥ 18.0	≥ 14.0	≥ 8.0	≤ 6.0

**6.7. Crosswalk Lighting**

- (a) An average maintained vertical illuminance of not less than 20 Lux measured at 1.5 m above the *road* surface with meter oriented towards approaching vehicle is required at crosswalks. This can be achieved by placing poles in advance of the crosswalk (see **Figure 6.5** below) to create high levels of vertical illumination thus improving driver visibility of pedestrians. This is covered in more detail in the Transportation Association of Canada Guide for the Design of *Roadway Lighting*.
- (b) This is primarily aimed at mid-block crosswalks and crosswalks at free right turn *lanes* where islands are present. It is doubtful crosswalk levels will be achieved for the main *road* crossings at signalized intersections; however, by placing the first lighting pole on the approach *roads* (away from the intersection) within one pole mounting height from the crosswalk, partial vertical illumination levels can be achieved at the crosswalk. Refer to the Transportation Association of Canada Guide for the Design of *Roadway Lighting* for further information and examples.

**Figure 6.5 Crosswalk Lighting Pole Placement**

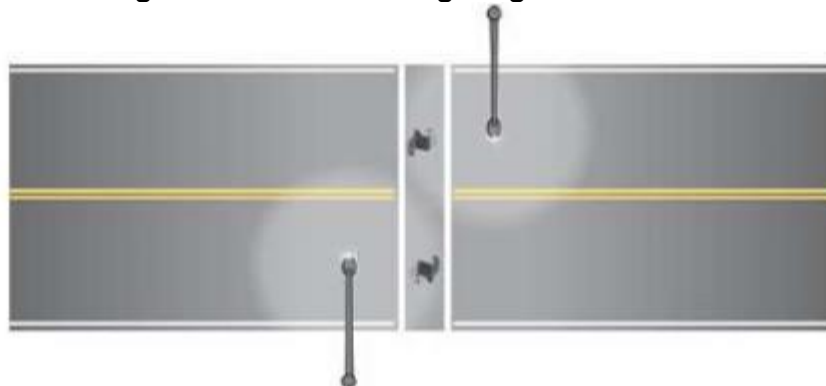

## 6.8. Walkways

- (a) Walkways and pathways which are remote from the street (greater than 5m away) shall be illuminated as follows:
- (i.) Maintained Average Horizontal Illuminance: 5 Lux or greater;
  - (ii.) Maximum to Minimum Uniformity Ratio: 10:1 or less; and
  - (iii.) Vertical illumination criteria and white light sources may also be considered where security is a concern. This improves facial recognition and aids in visibility. Refer to the Transportation Association of Canada Guide for the Design of *Roadway Lighting* for further information and examples.

## 6.9. Roundabout Lighting

- (a) Roundabouts have more complex visibility considerations than typical intersections. Key design considerations in lighting roundabouts include the following:
- The effectiveness of motor vehicle headlights is limited in a roundabout due to the constrained curve radius, making the street lighting system a necessity to aid in the nighttime visibility of obstructions, hazards, and pedestrians in crosswalks; and
  - Where there is no lighting on the approach streets, lighting shall be added on the approaches for approximately 80 m in advance of the roundabout crosswalks.
- (b) Lighting for a roundabout street surface shall meet or exceed the levels for an intersection. Crosswalks shall meet vertical lighting levels listed for crosswalks. For further information on Roundabout Lighting refer to the Transportation Association of Canada Guide for the Design of *Roadway Lighting* or IESNA DG-19-08 Design Guide for Roundabout Lighting.

## 6.10. Tunnel Lighting

- (a) Lighting for streets and sidewalks in tunnels less than 25m in length shall meet the lighting levels required for the approach street and sidewalk. Lighting may be required in the daytime depending on the amount of daylight penetration. Lighting for tunnels over 25m in length are covered in the IESNA RP-22-11 Recommended Practice for Tunnel Lighting.

## 6.11. Poles

- (a) Poles are to be per the Approved Products List. For *rural roads*, if approved by the *Director* and Summerland Electric Utility, lights may be installed on power poles.
- (b) Poles shall be located at the outer edges behind curb and gutter or edge of pavement, or in special circumstances, in the median of the street. The exact offset of the pole (behind curb, edge of pavement or sidewalk) is typically defined via standard *District of Summerland road* cross-section drawings which show all utilities and equipment locations for various *road* types. Where standard cross sections are not available then poles and foundation shall be located to:
- Provide at least 0.3m clearance from the back of curb of *roadway*;
  - Maintain wheelchair access on sidewalk; and
  - Not conflict with other utilities or overhead power lines.

- (c) In areas where speeds are over 60km/h with no curb and gutter, clear zones shall be considered in accordance with the Transportation Association of Canada Geometric Design Guide for Canadian *Roads*.
- (d) Pole spacing patterns include staggered, opposite and one side arrangements, depending on the *roadway* classification and *road* geometries. The pole arrangements shall generally be as follows:
  - *Roads* 9m and narrower - One sided spacing; and
  - *Roads* over 9.1m wide - Staggered or opposite spacing
- (e) A one-sided spacing may also be considered where overhead power line clearances can't be met.
- (f) Maintain clearances from features and utilities as follows:
  - (i.) 1.5 m: Pole to curb return or driveway let-down;
  - (ii.) 2.0 m: Pole to fire hydrant;
  - (iii.) 3.0 m: Overhead 25kV or lower voltage primary power lines. For higher voltages contact Summerland Electric Utility;
  - (iv.) 1.0m vertical and 1.0m horizontal: Secondary power lines (120V to 600V); and
  - (v.) 0.3m: Telephone and cable lines.
- (g) Where trees are proposed lights may have to be installed on davit arms which extend out over the *roadway* beyond the ultimate tree canopy. Additional pedestrian scale lighting (4m to 6m tall) may be required for the sidewalk to overcome blockage of light from the tree foliage. The proposed locations, spacing, pole height, arm length and frequency of the trees may also need to be adjusted in conjunction with the lighting pole spacing. A tighter pole spacing than calculated may be required to compensate for anticipated light blockage resulting in additional poles and luminaires. Where trees exist and impact the lighting, regularly scheduled tree pruning shall be considered.

## **6.12. Pole Foundations**

- (a) The *MMCD* Standard Specifications and Drawings define typical bases to support standard lighting poles. The designer is responsible for determining the suitability of these standard foundations for the given soil's conditions. Where soil conditions are in question a geotechnical engineer shall be consulted to define the suitability of the base for the given soil's conditions. Where foundations are not suitable, custom foundations will be required.
- (b) Where Map A.2 calls for decorative poles with banners and/or hanging baskets, the designer must review the additional loading by these elements and if required, design a custom base suitable to account for the additional loading on the pole.

## **6.13. Luminaires**

- (a) Cobra head luminaires shall meet the requirements listed in the BC Ministry of Transportation and Infrastructure Electrical and Signing Material Standards and meet the *Roadway Lighting*



energy performance standard CAN/CSA-C653, Performance Standard for *Roadway Lighting Luminaires*. CSA-C653 is based on defining common design criteria which will allow one to input various photometric files to computer lighting design software to compare product efficiency. CSA-C653 defines the maximum Unit Power Density (UPD) values for various *road* classifications, pedestrian conflict, *lane* configuration, and luminaire classifications.

- The designer shall consider luminaires from the Approved Products List.
- (b) Absolute photometric files in accordance with IESNA LM79-08 shall be used for each luminaire type, wattage, operating current, and photometric distribution.
- (c) The designer shall confirm the UPD and submit CSA C653 analysis with lighting calculations to verify performance standards are met for cobra head and LED luminaires.

**6.14. Power Supply and Distribution**

- (a) Power supply is required from the Summerland Electric Utility which supplies power. The designer shall confirm voltage and locations of suitable power sources for the proposed lighting system. *Roadway* lighting systems are typically serviced from a 120/240-volt single phase 3 wire system. Alternately, 120/208-volt 3 phase 4 wire or 347/600-volt systems may be used if necessary and if approved by the *Director*. Using 347/600V poses additional risk to maintenance personnel so where using this voltage labels indicating voltage shall be provided at all access points.
- (b) Lighting systems shall be fed via a service base from the Approved Products List.
- (c) Adaptive lighting control systems may also be considered to reduce power consumption and provide asset management.
- (d) Power is generally supplied by the Summerland Electric Utility through a metered service.
- (e) Services are to be “Underground Dip” type as shown on the *MMCD* Standard Specifications and Drawings. Grounding shall be as per *MMCD* Standard Specifications and Drawings.
- (f) Power distribution requirements include:
  - Wiring to be installed in minimum 50mm Rigid PVC conduit;
  - Wiring to be stranded copper with RW90 insulation;
  - Wiring to be colour coded per Canadian Electrical Code (CEC); and
  - Conduit burial depth as per *MMCD* Standard Specifications and Drawings.
- (g) Conduit alignments shall be designed to avoid tree roots.

## 6.15. Design

### 6.15.1. Lighting

- (a) Lighting design requires a computer lighting design software, and lighting supplier photometric files in IESNA format. LED photometric files must be “absolute” which means the photometric file must be for the exact luminaire being tested.

### 6.15.2. Decorative Lighting

- (a) Where Decorative Street Lighting is required to enhance the streetscape, as per Map A.2, luminaires and poles shall be from the Approved Products List.

### 6.15.3. Electrical

- (a) Design requirements include:
- Meet all requirements of the Canadian Electrical Code (CEC), latest edition, and bulletins issued by Electrical Safety Branch of the Province of British Columbia;
  - Maximum voltage drop for branch circuits: 3%;
  - Provisions for future expansion;
  - Conductor sizes: maximum #6 RW90; minimum #10 RW90 for branch circuits.
  - For branch circuits the load not to exceed 80% of the breaker rating (as per CEC);
  - Accommodation of loads for pole receptacles (300 W/receptacle), tree lights, and traffic signal controllers.
- (b) Traffic signal interconnection / communications conduit design shall be considered in conjunction with the street lighting designs of collector streets. The communications system shall be totally isolated from any power feeders. Minimum requirements shall be 75mm RPVC. The interconnection / communications conduits shall be common trenched with the street lighting conduit system. Junction boxes, with security lids, shall be installed where required.
- (c) All empty conduits shall have a 6 mm nylon pull string installed and capped ends.

### 6.15.4. Drawing Requirements

- (a) Lighting *design drawings* shall show all civil drawing information such as curbs, sidewalks, property lines, all physical features that may impact the lighting design, as well as the lighting poles, service/control equipment and wiring. Lighting drawings shall fully describe the proposed installation and all related existing lighting and electrical information. The detailed information required on the drawings shall include, but not be limited to the following:
- (i.) Site plan drawings at a scale of 1:500 showing pole locations, conduit, and service equipment. For beautification type projects, which have more electrical features such as pedestrian scale lighting and pole/tree receptacles, site plan drawings at a scale of 1:250 may be required. Poles and service equipment shall be located by station and offset. Conduit shall be located by offset from edge of pavement or face of curb and gutter;
  - (ii.) Legend and notes;

## Schedule C

### District of Summerland DESIGN STANDARDS

#### 6 – Roadway Lighting

---

- (iii.) Completed Lighting Design Criteria for each *road*, walkway, intersection, or roundabout;
  - (iv.) List of specific products such as luminaires (including any approved alternate luminaires), poles, anchor bolts and related hardware, junction boxes and service panels by manufacturer, make and model number; and
  - (v.) Drawings shall include sufficient street name and land or block location information to identify sections of *road* referenced in the lighting design summaries.
- (b) All lighting drawings shall be signed and sealed by a *Professional Engineer* registered with EGBC.
- (c) *Design drawings* shall be submitted for approval along with signed and sealed computer lighting calculations.

<b>7.</b>	<b>Traffic Signals.....</b>	<b>107</b>
7.1.	General.....	107
7.2.	Standardization.....	107
7.3.	Codes, Rules, Standards and Permits.....	108
7.4.	Signal Heads.....	108
7.5.	Pole Placement.....	111
7.6.	Left Turn Phasing.....	111
7.7.	Advanced Warning Flashers.....	112
7.8.	Signal Pre-emption.....	112
7.9.	Audible Pedestrian Signals.....	113
7.10.	Control Types.....	113
7.11.	Detection Methods.....	113
7.12.	Signal Timing Plans.....	114
7.13.	Signal Coordination.....	114
7.14.	Pedestrian Controlled Signals.....	114
7.15.	Poles and Foundations.....	115
7.16.	Controller Cabinets.....	115
7.17.	Controllers.....	115
7.18.	Power Supply and Distribution.....	115
7.19.	Uninterruptible Power Supplies (UPSs).....	116
7.20.	Signs.....	116
7.21.	Drawing Requirements.....	116

**7. Traffic Signals**

**7.1. General**

- (a) Traffic signals may be required to increase intersection capacity or enhance the safety of vehicular traffic or pedestrians. The need for a traffic signal may be determined by the *Director* or may be required based on warrants in accordance with the procedure indicated in Transportation Association of Canada Manual of Uniform Traffic Control Devices for Canada (MUTCDC).
- (b) These guidelines are not intended to be a substitute for sound engineering knowledge and experience. Traffic signal designs shall be prepared under the direction of a design professional who has the appropriate experience and is registered with Engineers and Geoscientists of British Columbia (EGBC).
- (c) Lighting requirements for intersections are defined in **6.0 - Roadway Lighting** and not repeated in this section.

**7.2. Standardization**

- (a) Traffic signal details are standardized throughout British Columbia to avoid potential confusion of the travelling public, both local and visiting. They are defined in the BC Motor Vehicle Act. Items standardized include a minimum of:
  - (i.) Vertical mounted signal heads;

- (ii.) Left side secondary heads; and
- (iii.) Order of signal indication.

### 7.3. Codes, Rules, Standards and Permits

Traffic signal systems are to be designed in general conformance with the following:

#### 7.3.1. Codes, Rules, and Regulations

- Canadian Electrical Code, latest edition, and bulletins issued by Electrical Safety Branch of the Province of British Columbia;
- American Association of State *highway* and Transportation Officials (AASHTO) Standard Specification for Structural Supports for Highway Signs, Luminaires and Traffic Signals or CAN/CSA-S6-00 Canadian Highway Bridge Design Code;
- WorkSafeBC;
- Canadian Standards Association (CSA);
- Summerland Electric Utility regulations; and
- Regulations issued by municipal, provincial, and federal authorities.

#### 7.3.2. Standards

- Canadian Standards Association (CSA);
- Summerland Electric Utility standards;
- *MMCD* Standard Specifications and Drawings, plus Supplementary Specifications and Drawings;
- BC Ministry of Transportation Electrical and Traffic Engineering Manual;
- Institute of Transportation Engineers (ITE);
- National Electrical Manufacturers Association (NEMA) - Traffic Controller Assemblies - TS1 or TS2;
- Canadian Manual of Uniform Traffic Control Devices (MUTCDC); and
- British Columbia Pedestrian Crossing Control Manual.

#### 7.3.3. Permits

- Electrical Permits as required by provincial or municipal authorities;
- Interconnection permits from Railroads, Ministry of Transportation and Infrastructure, or other authorities; and
- Right-of-way and utility crossing permits for crossings of electrical transmission lines, railways, *highways*, and regional, provincial, and federally regulated pipelines.

### 7.4. Signal Heads

(a) General locations of signal heads are as follows:

- Primary: Mounted over the *roadway* which a vehicle is travelling upon;
- Secondary: Mounted to the left of the *roadway* which a vehicle is travelling upon;
- Auxiliary: Mounted to the right of the primary head, or other location to enhance visibility; and
- Pedestrian: Mounted on the far side of the intersection in line with the painted crosswalk.

(b) Signal visibility distance is defined as the distance in advance of the stop line from which a signal must be continuously visible for approach speeds varying between 40 and 80 km/h. For

speeds exceeding 80 km/h, the minimum visibility distance must equal or exceed the minimum stopping sight distance. Visibility distance guidelines are shown on **Table 7.1** below.

**Table 7.1 Signal Head Visibility Distance Guidelines**

85 <sup>th</sup> Percentile Speed (km/h)	Minimum Visibility (m)	Desirable Visibility ⊙	Add For % Downgrade (m)		Subtract for % Upgrade (m)	
			5%	10%	5%	10%
40	65	100	3	6	3	5
50	85	125	5	9	3	6
60	110	160	7	16	5	9
70	135	195	11	23	8	13
80	165	235	15	37	11	20

- (c) Visibility of a signal head is influenced by three factors:
  - Vertical, horizontal, and longitudinal position of the signal head;
  - Height of driver's eye; and
  - Windshield area.
  
- (d) Lateral vision is excellent within 5° degrees of either side of the centreline of the eye position (10° cone) and adequate within 20° (40° cone). Horizontal signal position shall therefore be as follows:
  - Primary heads within the 10° cone; and
  - Secondary heads within the 40° cone.
  
- (e) Vertical vision is limited by the top of the windshield. Signal heads shall be placed within a 15° vertical sight line. Overhead signals shall be located a minimum of 15 m beyond the stop line. Refer to Canadian Manual of Uniform Traffic Control Devices (MUTCDC) for additional details.
  
- (f) Drivers of vehicles following high vehicles must be able to see at least one signal head upon reaching the dilemma point. The dilemma point is defined as the location where a driver's visibility of the signal indication goes from green to yellow and driver must decide either to bring the vehicle to a safe stop or proceed through and clear the intersection prior to the start of the conflicting green.
  
- (g) Major factors to consider in assessing signal head visibility are *road* geometry, design speed, spacing between vehicles, and the horizontal and vertical signal head locations.
  
- (h) Signal heads need to stand out from the surroundings to prevent confusion due to distractions. Primary signal heads shall have backboards. Backboards are optional for secondary and auxiliary heads. Backboards shall be yellow with a reflective surface. A 75mm fluorescent yellow retro-reflective tape border (ASTM Type 9 sheeting) on the outside edge of the entire backboard will increase signal visibility and is therefore recommended.
  
- (i) The effectiveness of flashing signals is influenced by flash rates. Recommended rates are:

# Schedule C

## District of Summerland DESIGN STANDARDS

### 7 – Traffic Signals

- Red and amber balls: 50 to 60 flashes per minute; and
  - Arrows: 100 to 120 flashes per minute.
- (j) The ON and OFF flash periods shall be equal.
- (k) Visors are required on all signal heads. Cowl-type visors are standard, except in the following cases, where tunnel visors are required:
- Fully protected left turn signal heads; and
  - At skewed intersections, where the signal heads may be viewed from other approaches.
- (l) Signal head sizes are to be as indicated in **Table 7.2** below.

**Table 7.2 Signal Head Sizes**

Signal Head Type	Area Classification Lens Size and Shape
Primary	300mm round
Secondary and Auxiliary	300mm round
	300mm round
Pedestrian	Combination walk/don't walk indication
	300 mm square
	Or
	Combination walk/don't walk indication with countdown timer 450 mm square

- (m) All signal displays shall be LED. These are preferred over the traditional incandescent lamps in terms of visibility and energy efficiency and reduced maintenance costs.
- (n) Signals shall be mounted on vertical posts or horizontal mast arms. Mounting heights are as indicated in *MMCD* Standard Drawings and as follows:
- Signals mounted above *roadways* shall have a minimum of 5.5 m clearance. Refer to BC Motor Vehicle Act for additional requirements;
  - Auxiliary signals shall be mounted at any height that meets visibility requirements and is between 1.25 m and 4.75 m above the *roadway*; and
  - Pedestrian heads shall be mounted at 2.5m above the *roadway* or sidewalk (whichever is higher).
- (o) Each signalized movement (phase) at an intersection requires a minimum of one primary and one secondary signal head. Additional signal heads may be required if visibility is a concern.

**Table 7.3 Signal Head Placement**

#### Straight Through Lanes

## Schedule C

### District of Summerland DESIGN STANDARDS

#### 7 – Traffic Signals

No. of Lanes	No. of Primary Heads	Placement of Primary Heads
One	One	Centred over through <i>lane</i>
Two	Two	Centred over each through <i>lane</i>
Three	Three	Centred over each through <i>lane</i>
Left Turn Lanes		
Left Turn Type	Primary Head Type	Placement of Primary Heads
Protected/Permissive	4 Sections with Flashing Green Arrow and Steady Yellow Arrow	Centred over left-most through <i>lane</i>
Protected – Single Left Turn <i>lane</i>	3 Sections with Steady Green Arrow	Centred on the left turn <i>lane</i> , either post mounted in median 2.5 m above <i>roadway</i> or mast-arm mounted
Protected – Dual Left Turn <i>Lanes</i>	3 Sections with Steady Green Arrow	Centred on the left turn <i>lane</i> , either post mounted in median 5.5 m above <i>roadway</i> or mast-arm mounted

#### 7.5. Pole Placement

- (a) Signal poles shall be placed between 1m and 3m from the face of curb or edge of pavement, preferably behind the sidewalk. Pole arms shall be oriented at 90° to the centreline of the *road*, except where the intersection is skewed. When laying out a skewed intersection, ensure the arms do not block the view of the signal heads for other approaches.
- (b) Other key considerations for pole placement are:
  - Ease of access to pushbutton for pedestrians, handicapped and the visually impaired in accordance with the TAC – Guidelines for Understanding, Use and Implementation of Accessible Pedestrian Signals;
  - Maintaining 1.2m wheelchair access around poles and from pushbuttons to wheelchair ramps;
  - Minimizing the number of poles required;
  - Locating poles outside vehicle turning radii to avoid damage;
  - Underground and overhead utility conflicts; and
  - For optimum visibility of vehicle and pedestrian heads.

#### 7.6. Left Turn Phasing

- (a) Left turn phasing options are as follows:
  - Permissive - Green ball display. A Permissive left turn has no signal indication other than a green ball, which permits a vehicle to turn left when there is a gap in the opposing traffic;



- Protected - Green arrow display. A Protected left turn presents a continuous green arrow indication while all opposing traffic is held by a red ball. A Protected Left Turn is always terminated with a yellow ball; and
  - Protected/Permissive – Yellow/Flashing Green arrow display. A Protected/Permissive left turn presents a flashing green arrow and yellow arrow followed by a green ball. During the flashing phase (advanced movement), opposing through traffic is held by a red ball. After the left turn phase has timed out, left turn traffic is presented with a green ball permitting the movement when safe. The protected green arrow is always terminated with a non-flashing yellow arrow indication.
- (b) Protected left turns are typically used in the following circumstances:
- Dual left turn *lane*;
  - Limited sight distance to oncoming vehicle;
  - High pedestrian volumes;
  - High speeds;
  - High collisions;
  - Left turn phase is in a lead-lag operation;
  - Split phasing; and
  - When crossing more than 2 *lanes* of traffic.
- (c) Protected/Permissive left turns are appropriate in cases where:
- Single left turn *lane*;
  - Good sight distance to oncoming vehicles;
  - Volumes warrant it; and
  - Low collisions probability.
- (d) Care shall be taken when considering a left turn phase, as it can impact the intersection level of service by increasing the total cycle length.

### 7.7. Advanced Warning Flashers

- (a) Advanced warning flashers shall be used where sight distance and grade to an intersection is less than optimal, or where design speed of the *road* is sufficiently high to justify warning motorists of signal status. Follow Ministry of Transportation and Infrastructure Electrical and Traffic Engineering Design Guidelines for the design and placement of Advance Warning Flasher Signs.

### 7.8. Signal Pre-emption

- (a) Traffic signals near rail crossings require interconnection with the rail crossing controls for driver safety. Refer to MUTCDC, Transport Canada Regulations and Ministry of Transportation and Infrastructure Electrical and Traffic Engineering Design Guidelines and the railway operator pre-emption requirements.
- (b) Some local authorities require emergency vehicle pre-emption to override normal signal operation and provide or terminate other phases for Emergency vehicles such as fire

department equipment and ambulances. Common emergency vehicle pre-emption systems operate using strobe lights, audio processing or optical signals. Each system has unique requirements for wiring, equipment, and operation. Refer to local fire department requirements and specific pre-emption system details.

## 7.9. Audible Pedestrian Signals

- (a) Where required by the *Director*, use audible pedestrian signals to assist visually impaired pedestrians.
- (b) The audible signal is interconnected with the Walk signal, and produces a “cuckoo” or “Canadian melody” sound, depending on the direction of crossing. The cuckoo sound is used for north-south crossings and the Canadian melody is used for east-west crossings. Where the streets are not oriented north-south and east-west, maintain consistency with adjacent signals.
- (c) Accessible pedestrian signals (APS) with voice messages, audible countdowns, tactile vibrating arrows, and locator beacons are available and shall be reviewed with the *District of Summerland*.

## 7.10. Control Types

- (a) The principal types of signal control are pre-timed (fixed time), and traffic actuated. Traffic actuated controls are categorized as fully actuated and volume density control. The type to be used will be determined from analysis and review with the *Director*. Signal types:
  - (i.) Pre-timed controls assign the right-of-way at an intersection according to a pre-determined schedule. The time interval for each signal indication is fixed according to this schedule. These are not typically very effective unless used in coordinated corridor;
  - (ii.) Fully Actuated controls require traffic detectors for all phases, with each phase timed according to pre-set parameters. Fully actuated controls allow for the maximum flexibility of signal control; and
  - (iii.) Volume Density control is a type of actuated control appropriate for major high-speed roads with unpredictable fluctuations in traffic volumes.

## 7.11. Detection Methods

- (a) Traffic detection for signal actuation is typically accomplished through one of the following methods:
  - Vehicle detector loops (induction); or
  - Image sensor (video detector system).
- (b) Other methods are available, and may be defined by local authorities. The method to be used will be determined by the *Director*.
- (c) A vehicle detector loop is a coil of wire buried in the road surface. The coil detects the presence of a vehicle by the change in electrical induction. This change is sensed by the detector module in the traffic control cabinet. Detector loop and image sensor locations and details are indicated

in the *MMCD* Standard Drawings. The image sensor system uses cameras and image sensing software to detect vehicles to send signals to the traffic controller.

**7.12. Signal Timing Plans**

- (a) Signal timing plans can be established using traffic counts and/or experience at similar intersections. Calculation methods and clearance times shall be in accordance with ITE Standards. Yellow and all red timings are of particular importance for the safe operation of a controlled intersection. The values for these times need to be assessed not only for a particular intersection, but on a municipal wide basis to ensure reasonable consistency for drivers. Contact the *Director* for specific requirements.

**7.13. Signal Coordination**

- (a) Delays to motor vehicles can be reduced on some traffic corridors by implementing a system to coordinate or synchronize traffic signal operation. A detailed traffic study is required to determine the potential effectiveness of a coordination system.
- (b) Coordination systems operate by coordinating the timing plans for each traffic signal controller with the timing plans of the adjacent controllers using the controller clocks. Timing “offsets” between intersections are based on distance and design speed. Signal controller clocks can be synchronized using radio signals, telephone connections or hard-wire interconnections between intersections. The most effective coordination systems include a master controller, which is in communication with all the intersection controllers. This allows for continuous clock synchronization and remote adjustment of system parameters.

**7.14. Pedestrian Controlled Signals**

- (a) There are two styles of pedestrian-controlled signals, a traffic signal with a green-yellow-red indication, and a special crosswalk signal. The requirement for a pedestrian signal and the type of signal to be installed will be established by the *District of Summerland* and shall be supported by Warrants as indicated in the BC Pedestrian Crossing Control Manual (MoTI).
- (b) Pedestrian signals serve pedestrian traffic only, and are generally placed in areas of high pedestrian traffic or in school *zones*. Pedestrian signals shall be located at intersections.
- (c) A full pedestrian signal has heads placed on the main *road* only. Cross street traffic is controlled by signage. When not activated, the signal presents a flashing green ball indication to drivers. When the signal is activated by a pedestrian, the flashing green ball indication becomes a steady green ball, followed by a yellow ball and then red. Pedestrian heads provide the Walk/Don't Walk indications to the pedestrian.
- (d) A Special Crosswalk Signal consists of pedestrian-controlled signage and lighting designed to draw driver attention to the crosswalk. The special crosswalk has illuminated overhead pedestrian crossing signs, with yellow flashing lights, and crosswalk luminaires. Some form of signal activation indication to the pedestrian may be required. Options include steady or flashing yellow light mounted on the

- (e) pole in line with the crosswalk, or LED indication on the pushbutton.
- (f) Where a suitable power source is not available or is costly to deliver to the site, solar powered crosswalks can be considered.

### **7.15. Poles and Foundations**

- (a) The *MMCD* Standard Specifications and Drawings define typical signal poles. Traffic signal poles shall be designed to accommodate the weight of the arms and the items mounted on the poles, as well as wind and ice loading, arm length, anchor bolt size and concrete base size.
- (b) The *MMCD* Standard Specifications and Drawings define typical bases to go with standard signals poles. The designer is responsible for determining the suitability of these standard foundations for the given soil's conditions. Where soils are in question a geotechnical engineer shall be consulted to define the suitability of the foundations for the given soil's conditions. Where foundations are not suitable, custom foundations will be required.

### **7.16. Controller Cabinets**

- (a) Controller cabinets are available in various sizes and styles depending on equipment requirements. *MMCD* Standard Drawings define cabinet and base sizes and installation methods. Cabinets shall be located entirely within the *road* right-of-way, including maintenance pad and door swing. Location shall be safe, so reasonably protected from motor vehicle damage, with access door on the side away from the sidewalk and the signals visible from the access.
- (b) Cabinets shall be NEMA 3R rated heavy gauge aluminium with grey powder coat exterior finish unless otherwise directed by the *District of Summerland*.

### **7.17. Controllers**

- (a) Traffic signal controllers shall be NEMA TS1 or TS2. The choice of manufacturer is to be approved by the *District of Summerland* with due consideration for the models already in use, availability of spare parts and experience of maintenance personnel.

### **7.18. Power Supply and Distribution**

- (a) Power supply is required from the Summerland Electric Utility which supplies power. The designer shall confirm voltage and locations of suitable power sources for the proposed signal system. Signals systems are typically serviced from a 120/240-volt single phase 3 wire system. Alternately, 120/208-volt 3 phase 4 wire systems may be used if necessary and if approved by the *District of Summerland*.
- (b) Power is generally supplied by the Summerland Electric Utility through a metered service when servicing streetlights and traffic signals. Services are to be "Underground Dip" type as shown on the *MMCD* Standard Specifications and Drawings, unless otherwise accepted by the *District of Summerland*. Grounding shall be as per *MMCD* Standard Specifications and Drawings

- (c) Power distribution requirements include:
- Wiring to be installed in minimum 50mm Rigid PVC conduit;
  - Wiring to be stranded copper with RW90 insulation;
  - Wiring to be colour coded per Canadian Electrical Code (CEC); and
  - Conduit burial depth as per *MMCD* Standard Drawings.
- (d) Signal wiring and conduit shall include a minimum of 3-53mm RPVC conduits or 2 -78mm RPVC conduits plus one additional empty conduit across at least 3 legs of the intersection. Junction boxes shall be provided at each corner of the intersection.

### 7.19. Uninterruptible Power Supplies (UPSs)

- (a) UPSs are required where traffic signals are interconnected by grade crossing warning systems as per Transport Canada. UPSs shall be considered where power outages are a concern, or the intersection is in a high collision or a high-risk area. UPSs are installed in NEMA 3R cabinets which can be mounted on the traffic controller cabinet or on their own concrete base. The duration of operation flash period during a power failure will define the UPS size and number of batteries required. The use of UPS shall be confirmed with the *District of Summerland*.
- (b) UPS type and manufacturers are listed on the BC Ministry of Transportation and Infrastructure Recognized Products List.

### 7.20. Signs

- (a) Street name signs shall be installed on signal pole arms. Signs can be bolted or banded or installed with manufactured sign mounting brackets. Signs shall be green background with 250mm high white clear-vue font (alternate colours may be required by the *District of Summerland*). Sign sheeting shall be ASTM Type 9. Local jurisdictions may also require internally illuminated LED signs. Confirm signing with local jurisdiction.
- (b) Other signs mounted on signal poles may include turn restriction signs, *lane* use signs, one-way signs, etc. as required by the BC Motor Vehicle Act and defined in the MUTCDC.
- (c) Railway crossing blank-out signs may be required where the signal is near a railway and a turning movement is restricted during railway pre-emption.

### 7.21. Drawing Requirements

- (a) Signal *design drawings* shall show all civil drawing information such as curbs, sidewalks, property lines, utilities, pavement markings, all physical features that may impact the signal design, as well as the signal and lighting poles, detector loops, service/control equipment and wiring. Signal drawings shall fully describe the proposed installation and all electrical and lighting information. The detailed information required on the drawings shall include, but not be limited to the following:

- (i.) Plan drawings at a scale of 1:250 showing pole locations, signal displays, pushbuttons, conduit, conductors and cables, advance warning signs, detector loops, controller, and service equipment. Poles and service equipment shall be located by station and offset. Conduit shall be located by offset from edge of pavement or curb and gutter;
  - (ii.) Legend and notes;
  - (iii.) Details including signal phasing diagram, pole elevations, detector loop table and wiring diagrams;
  - (iv.) Completed lighting Design Criteria Table as per Section 6 - Street Lighting; and
  - (v.) List of specific products such as luminaires, poles, anchor bolts and related hardware, junction boxes, pushbuttons, signals displays, mounting brackets and hardware, controller and cabinet, service panels, etc. by manufacturer, make and model number.
- (b) All signal drawings shall be signed and sealed by a *Professional Engineer* registered with EGBC.
- (c) *Design drawings* shall be submitted for approval and where required by the *District of Summerland* shall include signed and sealed signal timing sheets. An example timing sheet template is shown below. The actual timing sheets used shall be obtained from the controller supplier and they will specify elements specific to their controller which need to be addressed.

<b>8. Landscaping .....</b>	<b>118</b>
8.1. Objectives .....	118
8.2. Related Standards .....	118
8.3. Application of Standard .....	118
8.4. Landscape Consultant .....	119
8.5. Landscape Plan .....	119
8.6. Boulevards.....	119
8.7. Medians .....	119
8.8. Roundabouts, Traffic Circles and Cul-de-sac Islands .....	120
8.9. Stormwater Management Facilities .....	120
8.10. Erosion Control .....	121
8.11. Irrigation.....	121

**8. Landscaping**

**8.1. Objectives**

These design standards are intended to enhance the safety, aesthetics, and sustainability of *Public Lands* and to ensure efficiency and effectiveness of maintenance and operations of these lands.

**8.2. Related Standards**

- (a) This standard shall be referenced to and integrated with, at minimum, the following:
  - BC Landscape Standard, Current Edition;
  - Canadian Landscape Standard, Current Edition;
  - Okanagan Basin Water Board, Constructed Wetlands for Stormwater Management: An Okanagan Guidebook;
  - *District of Summerland*, Official Community Plan, *Development* Permit Area Wildfire guidelines;
  - FireSmart BC Landscaping Guide;
  - National Guide to Sustainable Municipal Infrastructure (Canada); and
  - Irrigation Association – Turf and Landscape Irrigation Best Management Practices.

**8.3. Application of Standard**

- (b) These standards apply to the following types of *Public Lands*, where landscaping is proposed in accordance with Section 5.3:
  - Boulevards;
  - Medians;
  - Roundabouts, Traffic Circles and *Cul-de-sac* Islands;
  - Recreation Corridors (trails, paths, walkways, etc);
  - *Public Access Routes*;
  - Stormwater Management Facilities; and
  - Erosion Control.

**8.4. Landscape Consultant**

- (a) The *Owner* shall retain a Landscape Consultant to be directly supervised by a Landscape Architect or a Registered Irrigation Designer. All Landscape drawings and specifications shall be sealed by a professional Landscape Architect. Irrigation drawings and specifications shall be prepared by a Registered Irrigation Designer.

**8.5. Landscape Plan**

- (a) The Landscape Designer shall consider, at minimum, the following criteria:
  - (i.) The functional relationship of the landscape design to existing and proposed land uses, utilities, flood patterns, drainage facilities, *roads*, driveways, and pedestrian facilities;
  - (ii.) Accessibility as it relates to pedestrians, cyclists, and people with limited physical or visual abilities;
  - (iii.) Horticultural use of plant material, including plant suitability, survival rate, growth habit, size, disease resistance and water demand;
  - (iv.) Trees and plant material to be approved by the *Director*;
  - (v.) Appearance of the proposed plant material and site landscape, including appropriateness, aesthetics, visual screening, and site lines;
  - (vi.) Protection of existing trees;
  - (vii.) Protection of the natural environment and restoration or enhancement of natural habitat;
  - (viii.) Site drainage, water levels, ponding and overland flow;
  - (ix.) Minimization of the opportunity for crime and undesirable behaviour;
  - (x.) Minimization of invasive plant material and weed control;
  - (xi.) Erosion control;
  - (xii.) Habitat control;
  - (xiii.) Fire hazard reduction;
  - (xiv.) The estimated costs and efficiency of maintenance practices that will be required for the *Public Land*; and
  - (xv.) Restoration of disturbed areas.

**8.6. Boulevards**

- (a) Boulevards within public *road* rights-of-way having an urban cross-section:
  - (i.) Street trees will only be required wherever feasible as noted on standard drawings and as per the *Director*.
  - (ii.) Grass surfaces may be permitted if drought tolerant species specified or irrigation is provided;
  - (iii.) Surfaces located between the back of curb or back of sidewalk may be landscaped; and
  - (iv.) Street trees may only be installed if permitted by the *Director*.

**8.7. Medians**

- (a) Medians may be landscaped.



- (b) Landscaping shall be approved on a site-specific basis.

**8.8. Roundabouts, Traffic Circles and Cul-de-sac Islands**

- (a) The following guidelines are the minimum requirements for all Landscape *Works and Services* in roundabouts, traffic circles and *cul-de-sac* islands:
  - (i.) The central area may, as lines of sight permit, feature a single specimen tree or a group of like trees with low groundcovers and/or shrub plantings. Alternatively, in the downtown core or urban areas may feature public art in place of trees. The selection, design and placement of public art shall be made in cooperation with the *Director*;
  - (ii.) For landscaped roundabouts, traffic circles and *cul-de-sacs* a complete and working automatic irrigation system shall be provided; and
  - (iii.) Lighting of trees or public art in a traffic circle shall be provided as required by the *Director*.

**8.9. Stormwater Management Facilities**

- a) A landscape plan, as per section 8.5 will be prepared and approved by the Director for bioswale, rain gardens and other similar stormwater management facilities.

**8.9.1. Wet Ponds**

- (a) Between the normal water level and the top of bank the side slopes shall be naturalized with low maintenance riparian plantings in 100mm minimum depth growing medium;
- (b) Above the top of bank, the ground surface shall be suitable drought resistant grass on 50mm depth smooth growing medium, with a maximum slope of 4 (horizontal) to 1 (vertical), except as required for vehicle access and pedestrian surfaces;
- (c) Shrubs and trees may be selected, planted, and maintained to provide screening, habitat, shade, and aesthetics as required.

**8.9.2. Dry Ponds**

- (a) The bottom of dry ponds and infiltration basins shall be suitable drought resistant grass on 50mm depth smooth growing medium.
- (b) Side slopes with a 4 (horizontal) to 1 (vertical) or shallower slope shall have a turf surface on 50mm minimum depth smooth growing medium. Side slopes steeper than 4 (horizontal) to 1 (vertical) slope shall be naturalized with low maintenance riparian plantings in 100mm minimum depth growing medium;
- (c) Above the design high water level, the ground surface shall be suitable drought resistant grass on 50mm depth smooth growing medium, with a maximum slope of 4 (horizontal) to 1 (vertical), except as required for vehicle access and pedestrian surfaces;
- (d) Shrubs and trees may be selected, planted, and maintained to provide screening, habitat, shade, and aesthetics as required

**8.10. Erosion Control**

- (a) Land proposed as *Public Land* where there is evidence of active or historic erosion that may have maintenance or liability implications for the *District* shall not be accepted by the *District* as *Public Land*.
- (b) The *Owner* shall be responsible for undertaking erosion control and restoration works on proposed *Public Land* as necessary for the long-term prevention and control of erosion.
- (c) At the discretion of the *Director*, the *Owner* may be required to prepare and submit an erosion control plan covering some or all the proposed *Public Land*.
- (d) The *Owner* is responsible for preventing and controlling erosion, and for restoring sites impacted by erosion, for the term of the *Maintenance Period*.

**8.11. Irrigation**

- (a) An irrigation system shall be designed, installed, operated, and maintained to provide sufficient application of water to maintain the plants and grass of the landscape *works and services* in a healthy and growing condition for the irrigation of *Public Land* to be maintained by the *Owner(s)*. If an irrigation system is not required at the time of *construction*, but will be required in the future, sufficient design, servicing, and *construction* shall be performed to enable the irrigation system to be readily installed, connected, and operated in future. The irrigation system shall be designed to include backflow prevention per CAN/CSA-B64.10-94 requirements.
- (b) Where *Public Land* is to be maintained by the *District*, an irrigation system shall be designed, operated, and maintained until the end of the *Maintenance Period*. One (1) metered water service and one (1) metered electrical service (120 volts, 60 amps) shall be provided for each park, open space, drainage facility, boulevard, median, roundabout, traffic circle and *cul-de-sac* island at a location acceptable to the *Director*. The service shall include the establishment of water and electrical service accounts, testing and certification of the backflow prevention device, a plumbing permit, an electrical permit, and all materials, labour, *fees*, and utility costs necessary to provide the service until the end of the *Maintenance Period*

<b>9.</b>	<b>Electrical, Communications Wiring and Gas Distribution .....</b>	<b>122</b>
9.1.	General .....	122
9.2.	Electrical .....	122
9.3.	Communications and Gas .....	123
9.4.	Utility Locations.....	123

**9. Electrical, Communications Wiring and Gas Distribution**

**9.1. General**

- (a) The applicant shall furnish all supervision, labour and materials necessary to *construct* the works required under the Bylaw. The works shall be *constructed* in strict accordance with detailed plans and specifications approved by the *Director*.
- (b) The *Owner* must obtain a letter of confirmation from the applicable utility that electrical, communication, and gas distribution infrastructure have been installed to their satisfaction.

**9.2. Electrical**

- (a) Electrical power supply systems and street lighting shall be approved by the *Director*. *Consulting Engineers* retained by the *Owner* to design the *works and services* must consult with the *Director* to determine what existing information may be of assistance to them.
- (b) The electrical systems must be designed and installed at the *Owner's* expense, in accordance with the requirements of the appropriate utility company standards and in accordance with all applicable Municipal codes and regulations, Provincial Statutes, regulations and/or standards.
- (c) It is standard practice that electrical design plans are prepared prior to design co-ordination with other utility companies. Details of design such as vertical and horizontal location of service boxes, size and type of conduits and gas mains, kiosk dimensions and ducting and all wiring details shall be as per specifications and drawings provided by the Summerland Electrical Utility and the appropriate telephone, cable, other electrical and gas utilities.
- (d) All wiring for new *development* shall be installed underground unless alterations to design are approved by the *Director*. The power distribution system shall consist of primary distribution switchgear, primary duct and conductor, transformer, secondary service duct and all related items for a complete installation.
- (e) Where overhead distribution is permitted, pole and anchor locations must be approved by the *Director* and any other affected company. Care must be taken to avoid aerial trespass, or conflicts with all other utility infrastructure. Plans and agreements for rights of way for anchors, pad-mounted transformers, etc., must be provided and registered in favor of the appropriate utility prior to *construction*.
- (f) Electrical systems must be provided to serve each *lot* within the *subdivision*. The location of all facilities and structures must be in accordance with the engineering drawings as approved by the *District*.

## Schedule C

### District of Summerland DESIGN STANDARDS

#### 9 - Electrical, Communications Wiring and Gas Distribution

---

- (g) Electrical transformers, junction boxes, vaults and streetlights are normally set at the projection of a *lot* line.
- (h) Designs shall eliminate location conflicts with other utilities such as fire hydrants, valves or splice boxes.

#### 9.3. Communications and Gas

- (a) Communication wiring, and gas service for each *parcel* must be designed and *constructed* in accordance with this Bylaw.

#### 9.4. Utility Locations

- (a) Systems of *works* for electrical, communications wiring and gas distribution systems must be installed in accordance with the standards required by the particular utility and any applicable federal and provincial codes.
- (b) All utility *work* must be installed in alignments as generally indicated on Standard Drawings. It is the responsibility of the *Owners Engineer* to coordinate with each utility the actual offsets required prior to a drawing submission to the *District*.
- (c) All systems must be designed and *constructed* so as to fully service all *parcels* in a *subdivision* or *development*.

**Schedule C**

District of Summerland  
**DESIGN STANDARDS**

**9 - Electrical, Communications Wiring and Gas Distribution**

---

**10. Standard Drawings..... 124**

---

**10. Standard Drawings**

Drawing Name	Drawing Number
Lane (Centre Swale Drainage)	100-1
Lane (Cross Fall Drainage)	100-2
Industrial	100-3
Rural Local	100-4
Urban Local	100-5
Rural Collector	100-6
Urban Collector – no parking	100-7
Urban Collector - parking	100-8
Hillside Local	100-9
Prairie Valley Road	100-10
Lakeshore Drive	100-11

THE CORPORATION OF THE  
DISTRICT OF SUMMERLAND

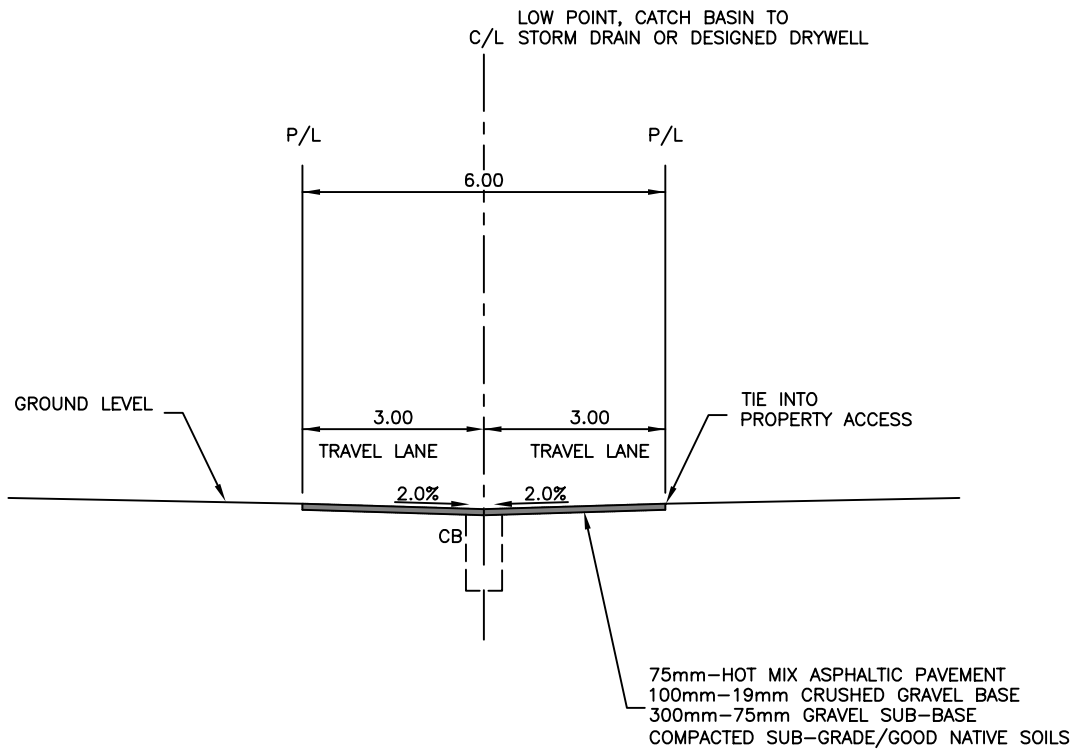

LANE STANDARDS

NO. OF PARKING STALLS/BYLAW	R/W WIDTH	PAVE WIDTH	PAVED ADJ. FRONTAGE	PAVE TO NEAR STREET	CATCH BASIN TO DRYWELL
RESIDENTIAL - 2 STALLS	6.0	6.0	NO	NO	NO
DUPLEX - 2-4 STALLS	6.0	6.0	YES	NO	NO
MULTIPLE FAMILY COMMERCIAL a. LESS THAN 20 STALLS	6.0	6.0	YES	NO	NO
MULTIPLE FAMILY COMMERCIAL b. EXCEED 20 STALLS	6.0	6.0	YES	YES	YES

**NOTE:**

THE STRUCTURAL ROAD ELEMENTS SHOWN ARE THE MINIMUM REQUIREMENTS. THE ROAD STRUCTURE IS TO BE DESIGNED BASED ON SITE SPECIFIC SOIL CONDITIONS TRAFFIC LOADINGS.

STANDARD  
DETAIL  
DRAWING

LANE  
(CENTRE SWALE DRAINAGE)

NOT TO SCALE

DIVISION:  
ROADS

REVISED: AUGUST 2022

DRAWING NUMBER:  
100-1

THE CORPORATION OF THE  
DISTRICT OF SUMMERLAND

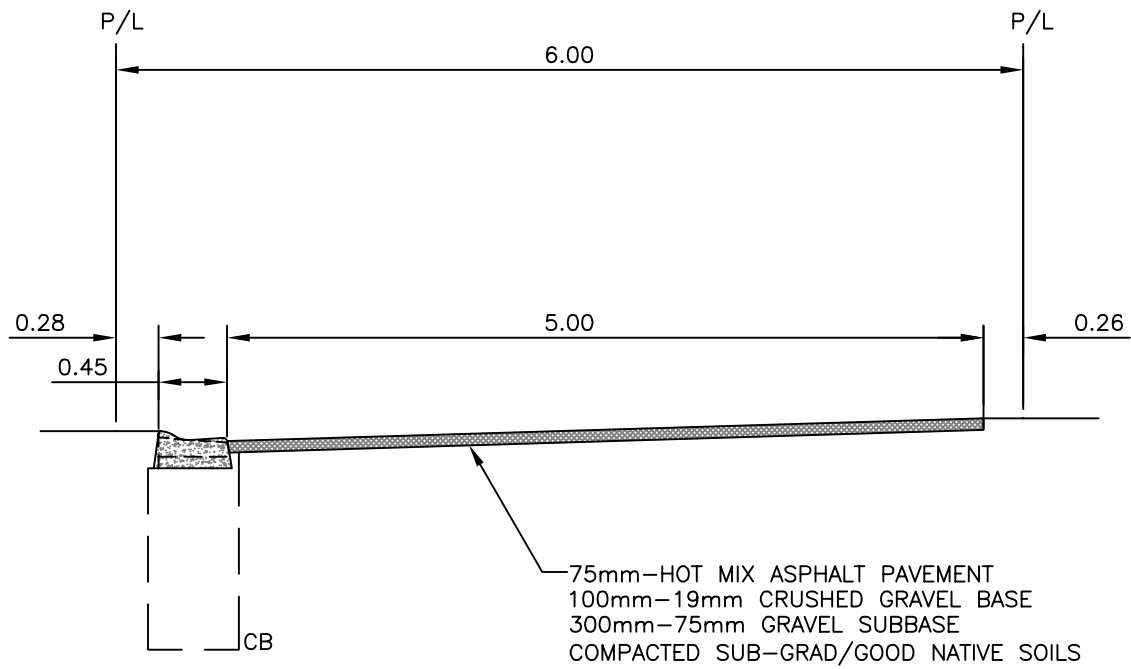

**NOTE:**

THE STRUCTURAL ROAD ELEMENTS SHOWN ARE THE MINIMUM REQUIREMENTS. THE ROAD STRUCTURE IS TO BE DESIGNED BASED ON SITE SPECIFIC SOIL CONDITIONS TRAFFIC LOADINGS.

STANDARD  
DETAIL  
DRAWING

LANE  
(CROSS FALL DRAINAGE)  
NOT TO SCALE

DIVISION:  
ROADS

REVISED: JUNE 2022

DRAWING NUMBER:  
100-2

THE CORPORATION OF THE  
DISTRICT OF SUMMERLAND

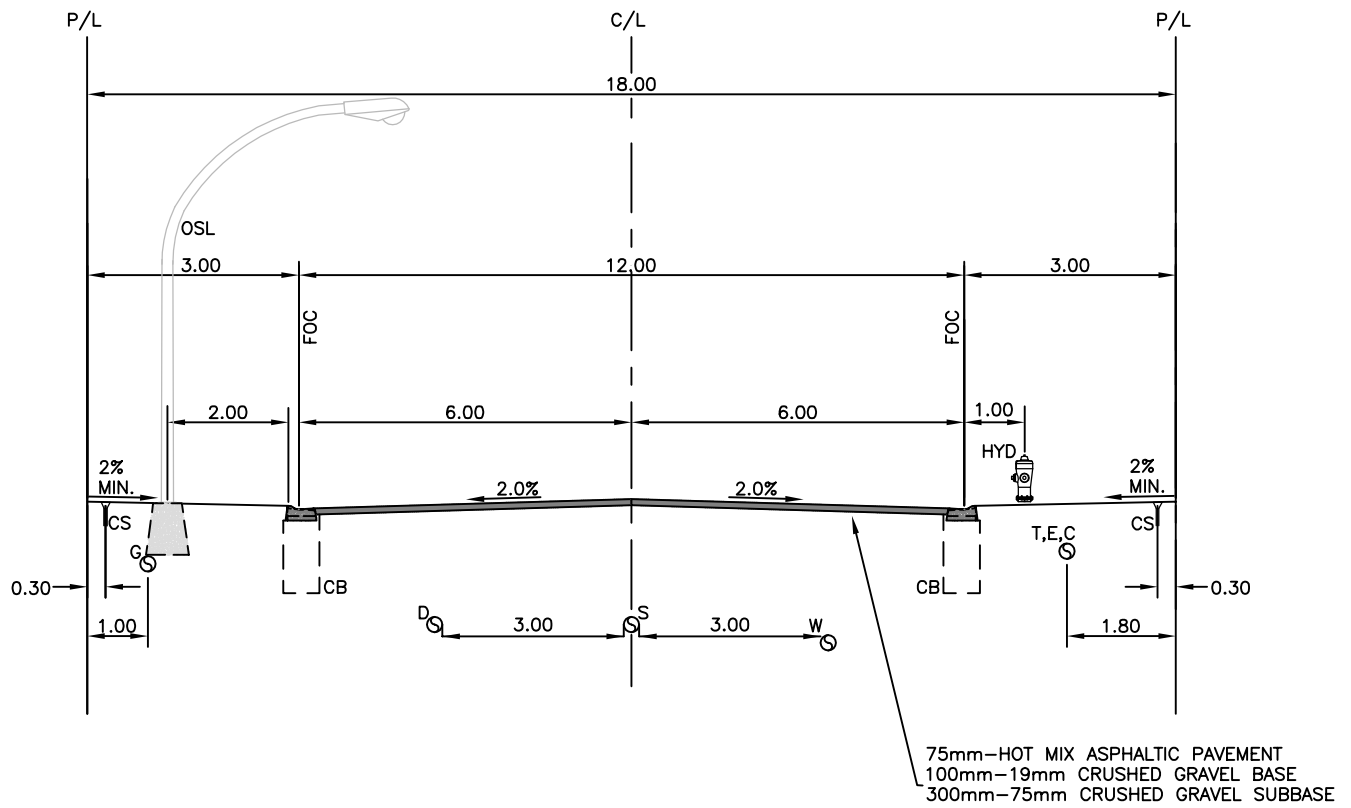

**NOTE:**

THE STRUCTURAL ROAD ELEMENTS SHOWN ARE THE MINIMUM REQUIREMENTS. THE ROAD STRUCTURE IS TO BE DESIGNED BASED ON SITE SPECIFIC SOIL CONDITIONS TRAFFIC LOADINGS.

STANDARD  
DETAIL  
DRAWING

INDUSTRIAL

NOT TO SCALE

DIVISION:  
ROADS

REVISED: JUNE 2022

DRAWING NUMBER:  
100-3



THE CORPORATION OF THE  
DISTRICT OF SUMMERLAND

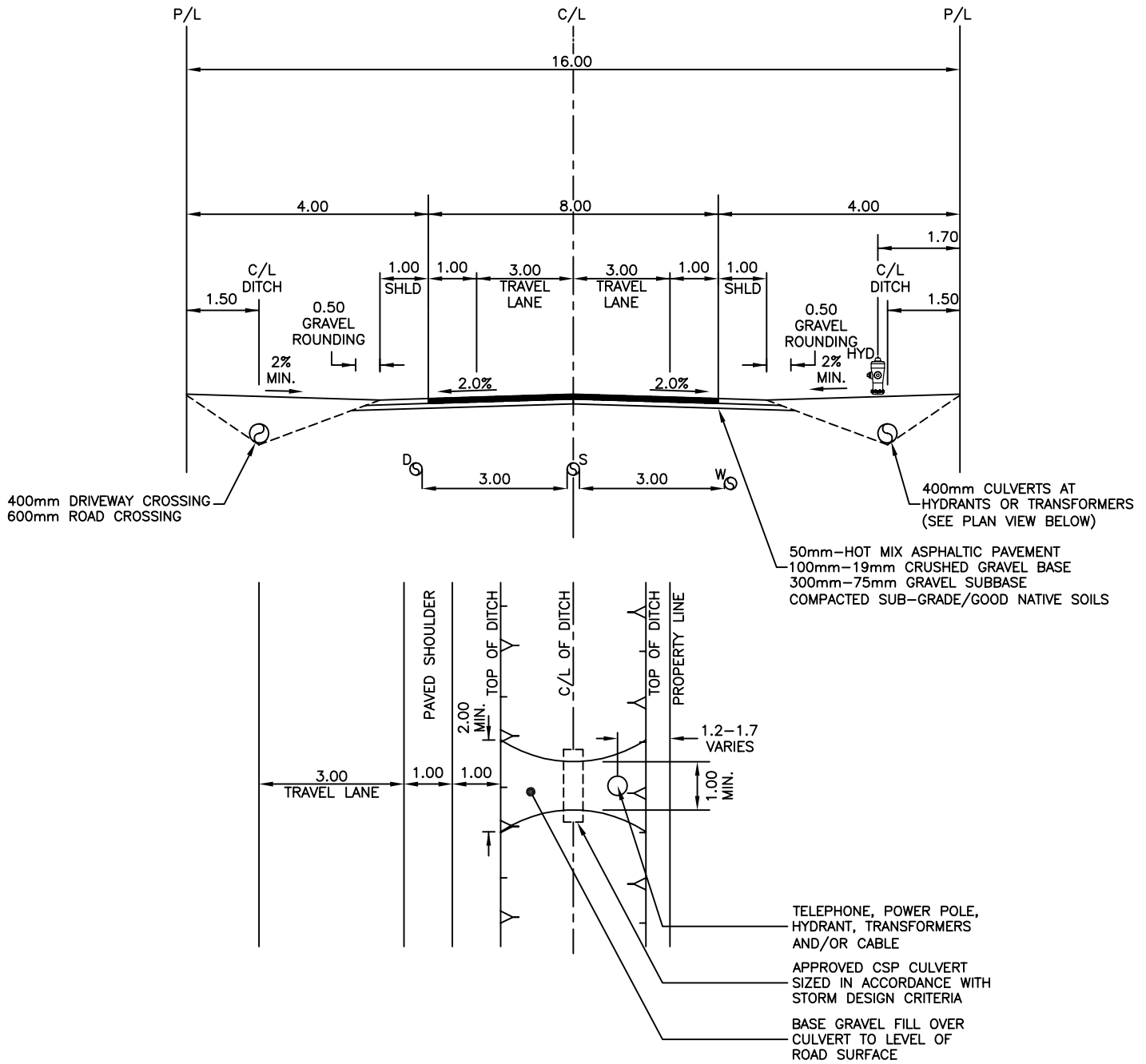

PLAN VIEW OF HYDRANT & POLES NEAR DITCHES

NOTES:

1. THE MAXIMUM DRIVEWAY GRADE SHALL BE 20% THE MAXIMUM BOULEVARD SLOPE SHALL BE NO GREATER THAN 50% OF DRIVEWAY GRADE (10%)
2. 16ga CORRUGATED METAL CULVERTS SHALL BE INSTALLED IN ALL DRIVEWAYS OF COUNTRY RESIDENTIAL TYPE ROADS. THE MINIMUM SIZE SHALL BE 300mm DIA OR LARGER IF REQUIRED BY THE DRAINAGE AREA.
3. THE ROAD STRUCTURE IS TO BE DESIGNED BASED ON SITE SPECIFIC SOIL CONDITIONS TRAFFIC LOADINGS.

STANDARD  
DETAIL  
DRAWING

RURAL LOCAL ROAD

NOT TO SCALE

DIVISION:  
ROADS

REVISED: AUGUST 2022

DRAWING NUMBER:  
100-4

THE CORPORATION OF THE  
DISTRICT OF SUMMERLAND

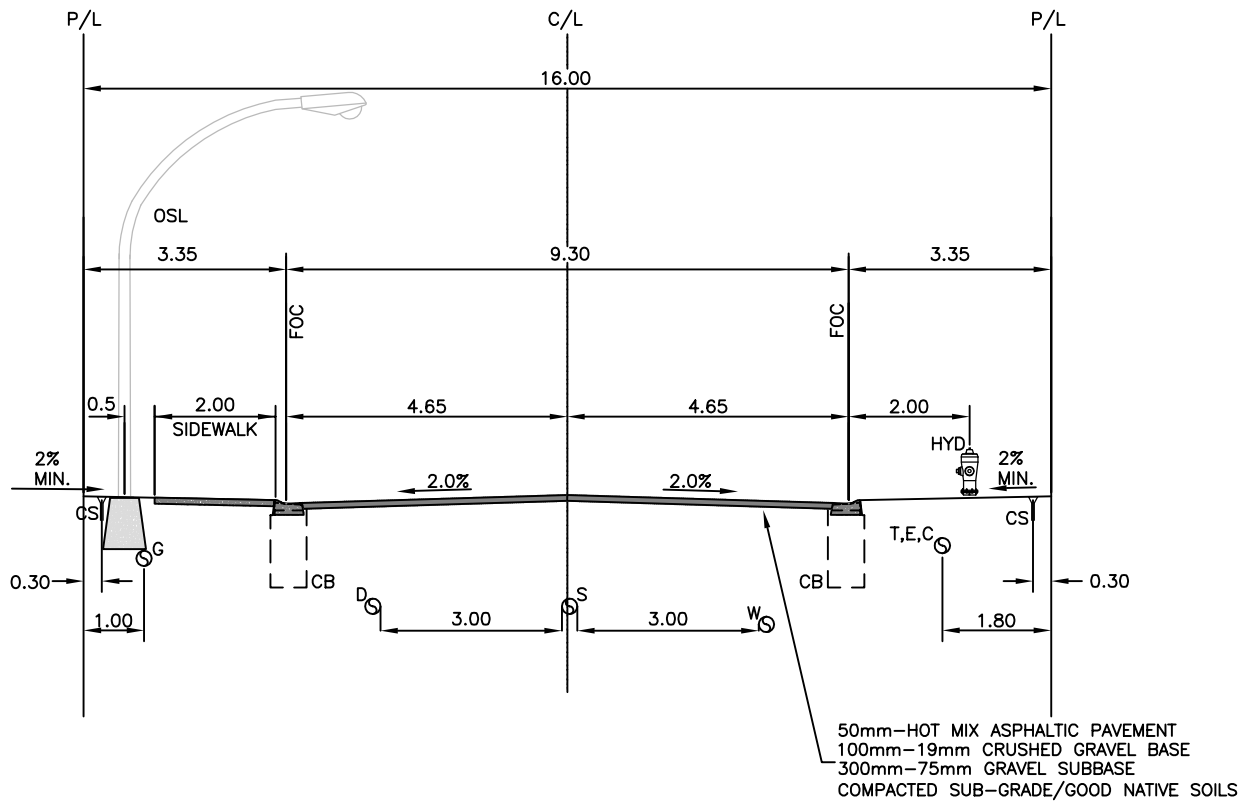

**NOTE:**

1. THE MAXIMUM DRIVEWAY GRADE SHALL BE 20%. THE MAXIMUM BOULEVARD SLOPE SHALL BE NO GREATER THAN 50% OF DRIVEWAY GRADE (10%).
2. 16ga CORRUGATED METAL CULVERTS SHALL BE INSTALLED IN ALL DRIVEWAYS OF COUNTRY RESIDENTIAL TYPE ROADS. THE MINIMUM SIZE SHALL BE 300mm DIA OR LARGER IF REQUIRED BY THE DRAINAGE AREA.
3. THE ROAD STRUCTURE IS TO BE DESIGNED BASED ON SITE SPECIFIC SOIL CONDITIONS TRAFFIC LOADINGS.
4. SIDEWALK LOCATION TO BE DEPENDENT ON SIDEWALK MASTER PLAN

STANDARD  
DETAIL  
DRAWING

URBAN LOCAL ROAD

NOT TO SCALE

DIVISION:  
ROADS

REVISED: AUGUST 2022

DRAWING NUMBER:  
100-5

THE CORPORATION OF THE  
DISTRICT OF SUMMERLAND

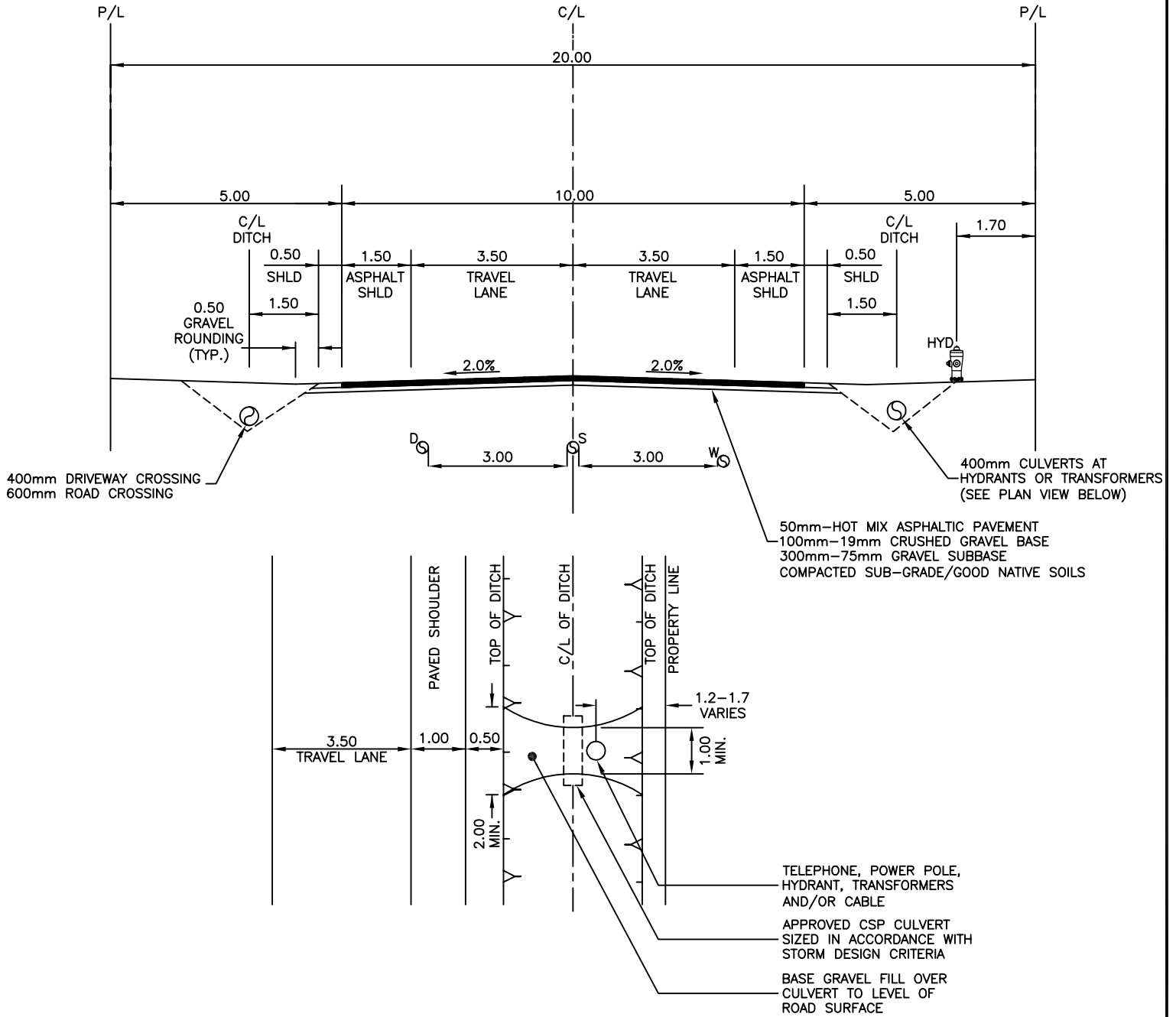

PLAN VIEW OF HYDRANT & POLES NEAR DITCHES

NOTES:

1. THE MAXIMUM DRIVEWAY GRADE SHALL BE 20% THE MAXIMUM BOULEVARD SLOPE SHALL BE NO GREATER THAN 50% OF DRIVEWAY GRADE (10%)
2. 16ga CORRUGATED METAL CULVERTS SHALL BE INSTALLED IN ALL DRIVEWAYS OF COUNTRY RESIDENTIAL TYPE ROADS. THE MINIMUM SIZE SHALL BE 300mm DIA OR LARGER IF REQUIRED BY THE DRAINAGE AREA.
3. THE ROAD STRUCTURE IS TO BE DESIGNED BASED ON SITE SPECIFIC SOIL CONDITIONS TRAFFIC LOADINGS.

STANDARD  
DETAIL  
DRAWING

RURAL COLLECTOR ROAD

NOT TO SCALE

DIVISION:  
ROADS

REVISED: AUGUST 2022

DRAWING NUMBER:  
100-6

THE CORPORATION OF THE  
DISTRICT OF SUMMERLAND

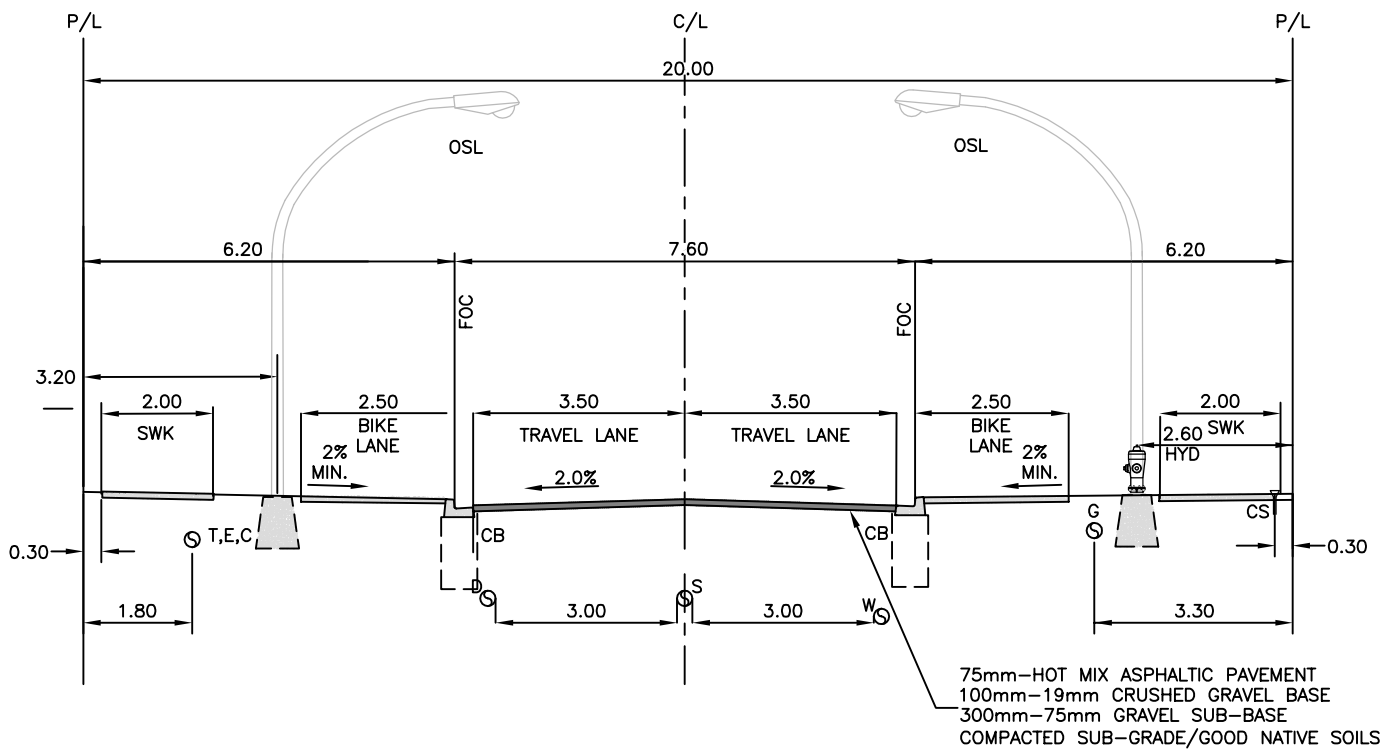

**NOTE:**

THE STRUCTURAL ROAD ELEMENTS SHOWN ARE THE MINIMUM REQUIREMENTS. THE ROAD STRUCTURE IS TO BE DESIGNED BASED ON SITE SPECIFIC SOIL CONDITIONS TRAFFIC LOADINGS.

STANDARD  
DETAIL  
DRAWING

URBAN COLLECTOR ROAD  
(NO PARKING)

NOT TO SCALE

DIVISION:  
ROADS

REVISED: AUGUST 2022

DRAWING NUMBER:  
100-7



THE CORPORATION OF THE  
DISTRICT OF SUMMERLAND

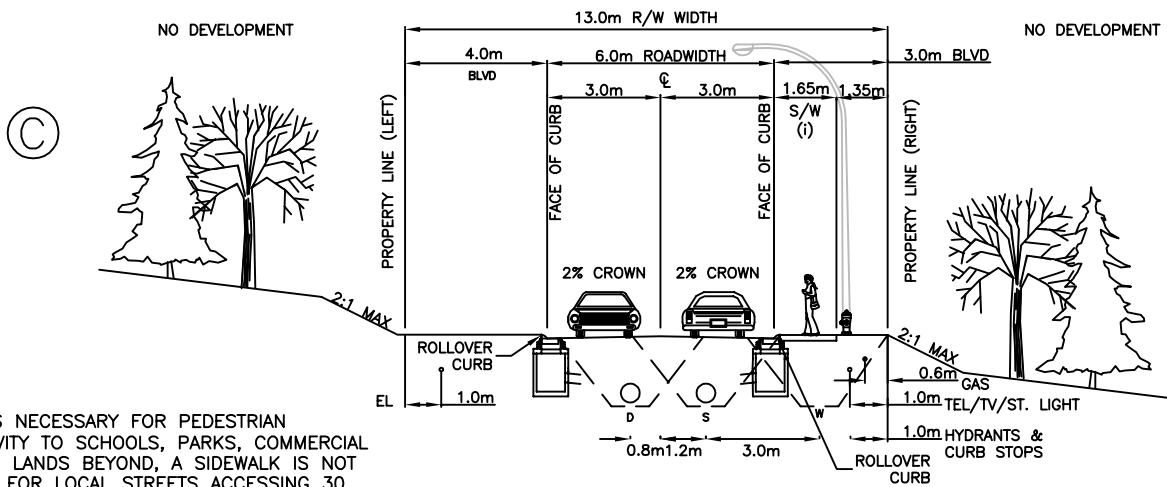
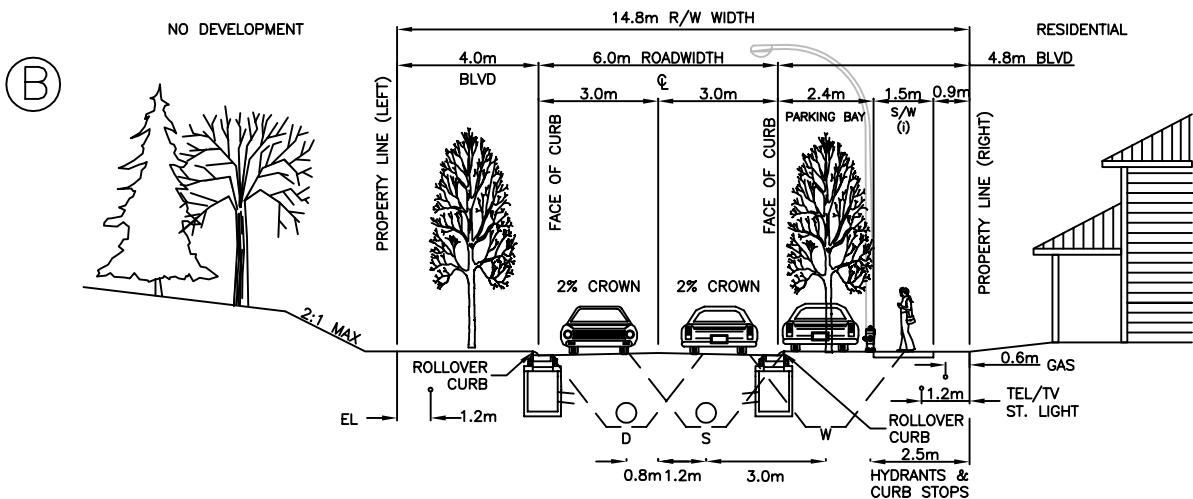
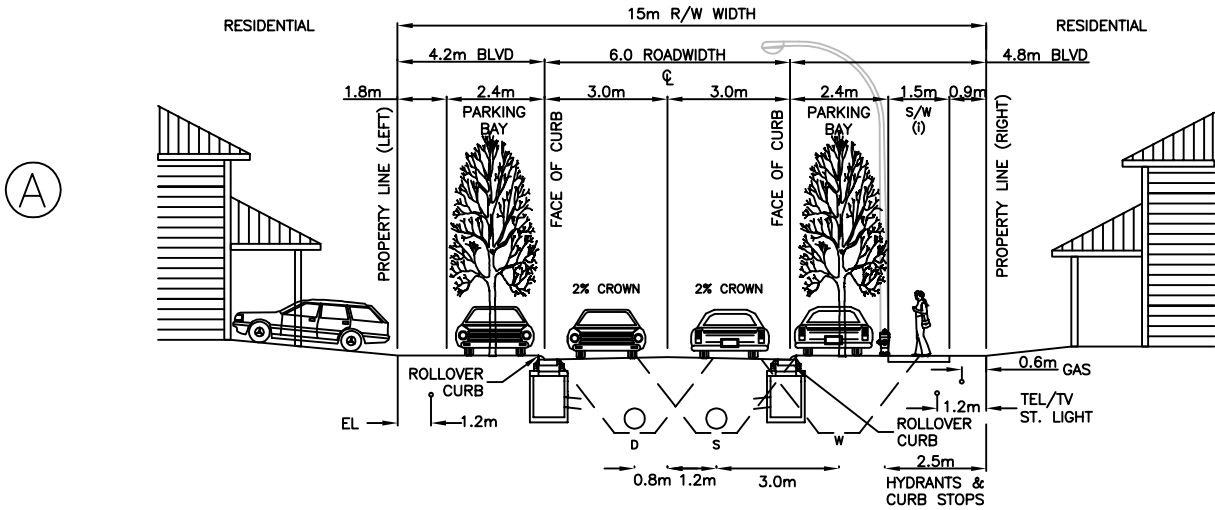

NOTE:

- (i) - UNLESS NECESSARY FOR PEDESTRIAN CONNECTIVITY TO SCHOOLS, PARKS, COMMERCIAL AREAS OR LANDS BEYOND, A SIDEWALK IS NOT REQUIRED FOR LOCAL STREETS ACCESSING 30 LOTS OR LESS. THE STREET ROW WIDTH MAY BE REDUCED ACCORDINGLY

STANDARD  
DETAIL  
DRAWING

HILLSIDES - LOCAL

NOT TO SCALE

DIVISION:  
ROADS

REVISED: AUGUST 2022

DRAWING NUMBER:  
100-9

THE CORPORATION OF THE  
DISTRICT OF SUMMERLAND

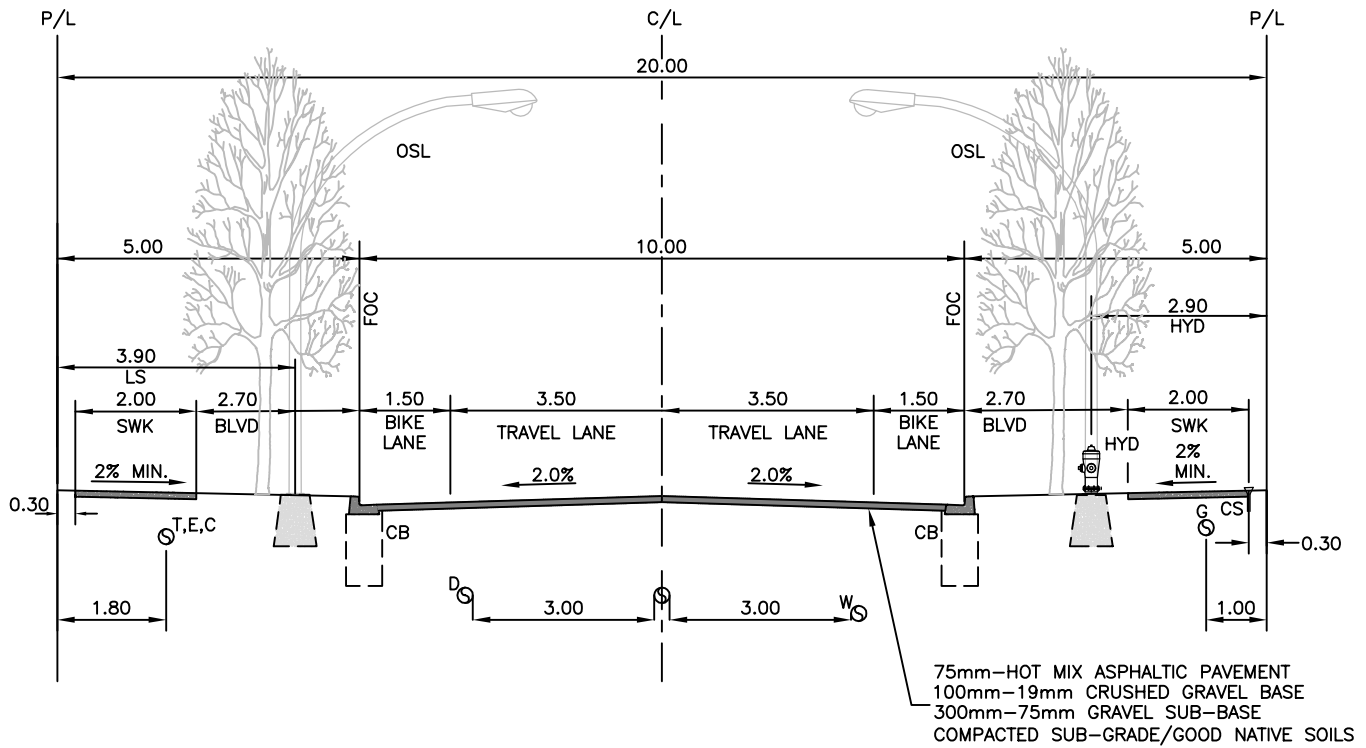

**NOTE:**

THE STRUCTURAL ROAD ELEMENTS SHOWN ARE THE MINIMUM REQUIREMENTS. THE ROAD STRUCTURE IS TO BE DESIGNED BASED ON SITE SPECIFIC SOIL CONDITIONS TRAFFIC LOADINGS.

STANDARD  
DETAIL  
DRAWING

PRAIRIE VALLEY ROAD  
VICTORIA ROAD TO CARTWRIGHT AVENUE  
NOT TO SCALE

DIVISION:  
ROADS

REVISED: AUGUST 2022

DRAWING NUMBER:  
100-10

THE CORPORATION OF THE  
DISTRICT OF SUMMERLAND

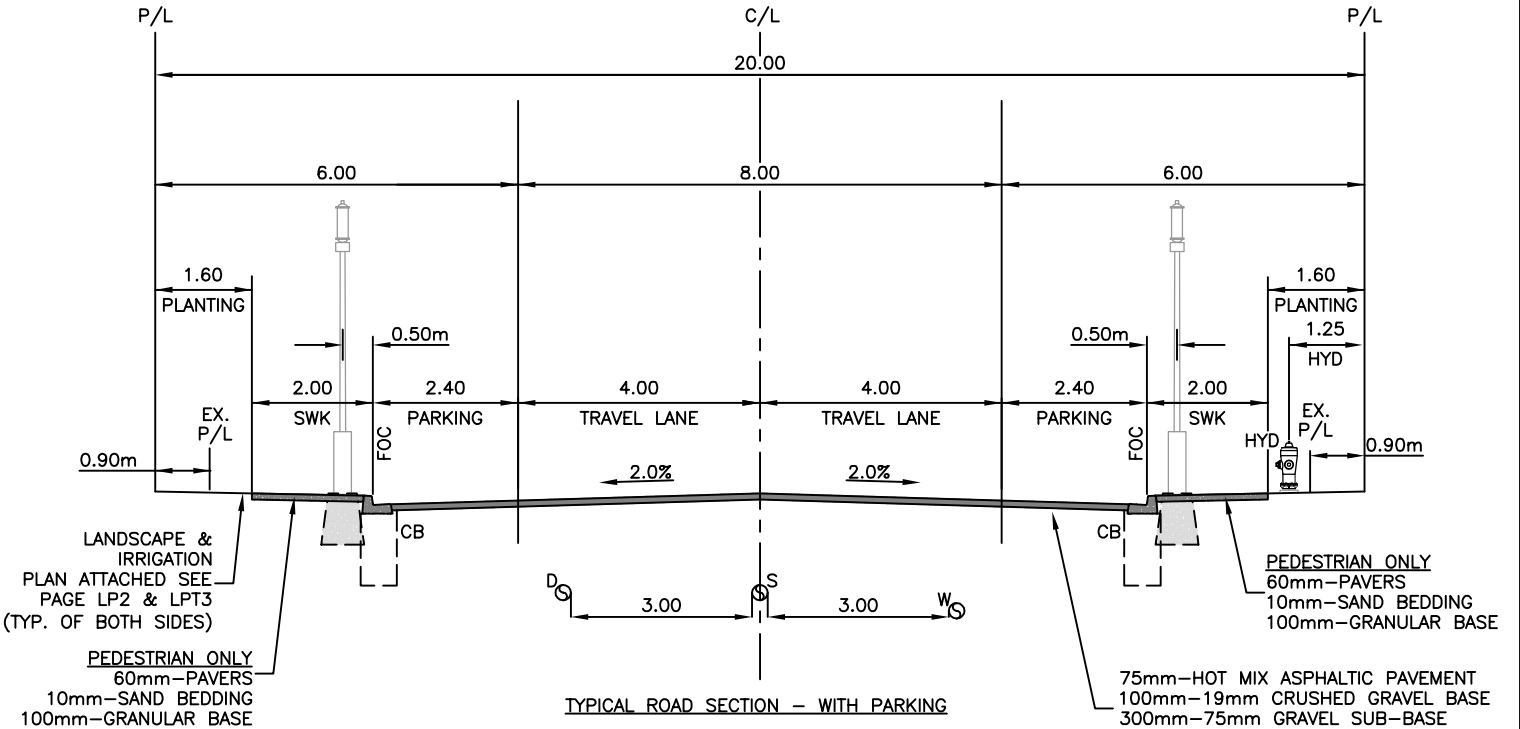
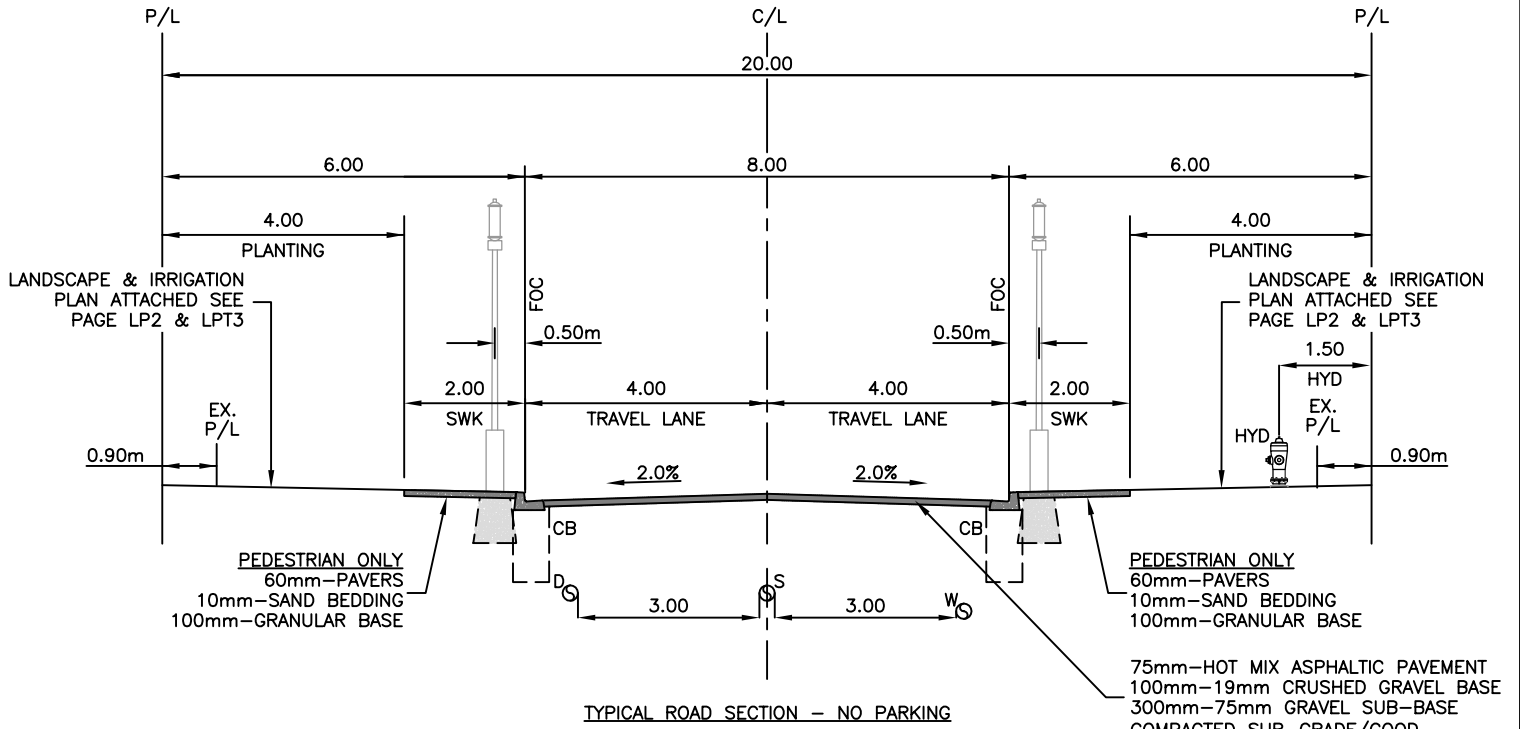

**NOTE:**  
THE STRUCTURAL ROAD ELEMENTS SHOWN ARE THE MINIMUM REQUIREMENTS. THE ROAD STRUCTURE IS TO BE DESIGNED BASED ON SITE SPECIFIC SOIL CONDITIONS TRAFFIC LOADINGS.

STANDARD DETAIL DRAWING	LAKESHORE DRIVE NOT TO SCALE	DIVISION: ROADS	DRAWING NUMBER: 100-11
		REVISED: JUNE 2022	



## **Schedule D CONSTRUCTION SUPPLEMENTARY SPECIFICATIONS**

---

### **Construction Supplementary Specifications**

This schedule contains supplemental specifications to be applied in conjunction with the Specifications of the Master Municipal Construction Document. Both of which shall apply to all *Works and Services Constructed* within the District of Summerland.

Supplemental Specifications contained within this Schedule supplement or supersede the Master Municipal Construction Document (*MMCD*). Where the District of Summerland Supplemental Specifications conflict with the *MMCD*, the District of Summerland Supplemental Specifications shall take precedence.

Section number and clause numbers in the District of Summerland Supplemental Specifications coincide with the *MMCD* numbering protocol.

### **Table of Contents**

<b>SS 01 55 00</b>	<b>Traffic Control, Vehicle Access and Parking</b>
<b>SS 01 57 01</b>	<b>Environmental Protection</b>
<b>SS 03 40 01</b>	<b>Precast Concrete</b>
<b>SS 26 56 01</b>	<b>Roadway Lighting</b>
<b>SS 31 23 23</b>	<b>Controlled Density Fill</b>
<b>SS 32 12 16</b>	<b>Hot Mix and Warm Mix AC Paving</b>
<b>SS 33 11 01</b>	<b>Waterworks</b>
<b>SS 33 11 02</b>	<b>Horizontal Directional Drilling</b>
<b>SS 33 40 01</b>	<b>Storm Sewers</b>
<b>SS 33 44 01</b>	<b>Manholes and Catchbasins</b>

## **Schedule D CONSTRUCTION SUPPLEMENTARY SPECIFICATIONS**

---

### **MMCD Section 01 55 00S TRAFFIC CONTROL, VEHICLE ACCESS AND PARKING**

#### **GENERAL**

Delete 1.0.6 and replace with the following:

The Contractor is responsible for all temporary traffic control required to complete the Work. The Contractor will be responsible to provide a Traffic Management Plan (TMP) which utilizes the *BCMOTI template for Traffic Management Plans* (June 2017) for review and acceptance by the District (10) ten working days prior to any travel lane closures taking place. TMP is to be prepared by a qualified professional.

The TMP shall outline the approach to traffic management, show recognition and minimization of risks indicates signing locations, identify Traffic Control Persons (TCP) stations, show lane shifting and proposed closures.

The TMP is to be revised and resubmitted as required during the progress of the work.

## **Schedule D CONSTRUCTION SUPPLEMENTARY SPECIFICATIONS**

---

### **MMCD Section 01 57 01S ENVIRONMENTAL PROTECTION**

#### **1.0 GENERAL**

#### **1.2 Temporary Erosion and Sediment Controls**

Add 1.2.1.4 as follows:

An Erosion & Sediment Control (ESC) Plan must be prepared by a Certified Professional in Erosion and Sediment Control. The ESC Plan is to be reviewed by the District prior to the start of construction. Protection of the site and watercourses to which it drains, directly or indirectly, against erosion and siltation must be maintained in accordance with the ESC Plan until the Works are completed or as directed by the Contract Administrator. The Contractor is responsible for all damage that may be caused by water backing up or flowing over, through from or along any part of the Work or otherwise resulting from their operations.

Add 1.2.1.5 as follows:

Keep existing culverts, drains, ditches and watercourses affected by the Work clear of excavated material at all times. When it is necessary to remove or alter any existing drainage structure, provide suitable alternative measures for handling the drainage. Adequately support culverts and drainpipes across trenches to prevent displacement and interference with the proper flow of water due to trench settlement.

Add 1.2.1.6 as follows:

Sweep streets, and clean catch basins, manhole sumps, detention tanks, and maintain siltation controls as often as the Contract Administrator deems necessary.

#### **1.9 Archeological / Historical Resources**

Add 1.9.1 as follows:

Immediately cease work and inform the Contract Administrator, if any archaeological or historical resources are encountered during construction. Leave these resources in place and do not disturb them in any way.

## **Schedule D CONSTRUCTION SUPPLEMENTARY SPECIFICATIONS**

---

### **1.10 Removal and Disposal of Accumulated Soils**

Add 1.10.1 as follows:

Upon completion of construction or at any time during construction where soil accumulates on public roads, sidewalks, or in drainage systems as a result of construction activity in the subdivision or development, the Owner must remove and dispose of the accumulated soil. If the Owner fails to remove or dispose of the accumulated soil within 72 hours of notification from the District of Summerland, the District of Summerland may remove and dispose of the accumulated soil at the expense of the Owner.

### **MMCD Section 03 40 01      PRECAST CONCRETE**

#### **2.0 PRODUCTS**

##### **2.1 Materials**

Add 2.1.2 as follows:

Type 50 (High Sulphate Resistant) concrete to be used for the manufacture of all concrete products incorporated into this project.

## **Schedule D CONSTRUCTION SUPPLEMENTARY SPECIFICATIONS**

---

### **MMCD Section 26 56 01S ROADWAY LIGHTING**

#### **2.0 PRODUCTS**

##### **2.1 General**

Delete 2.1.2 and replace with the following:

All products supplied to be new, in accordance with Contract Documents. All products are to meet Canadian Electrical Code requirements and be certified by either CSA, ULC, or Intertek Testing Systems (Warnock Hersey) and be supplied with the certifier's label.

##### **2.8 Conductors and Cables**

Delete 2.8.1 and replace with the following:

Single Conductors: 600V, conductor size (AWG) as noted on contract drawings, stranded copper or aluminum type with RW90 polyethylene insulation, to conform to CSA C22.2 No. 38, 90 0C and colour coded per CEC.

Add 2.8.5 as follows:

Minimum conductor size to be as follows, unless specified otherwise on Contract Drawings:

- .1 No 8 AWG copper or No 6 AWG aluminum for feeder conductors in conduit.
- .2 No 8 AWG copper or No 6 AWG aluminum for bond conductors in conduit.
- .3 No 12 AWG copper for luminaire conductors in poles

##### **2.14 Luminaires**

Revise 2.14.1 as follows:

Luminaires: CSA Approved LED Luminaries with flat faced cut-off lenses.

##### **2.19 Service Panels**

Add 2.19.1 as follows:

Type 40A 120/240V, 60A 120/240V roadway lighting and 100A 120/240V combination roadway lighting / traffic signal, per Contract Drawings to include items listed within the Section 34 41 13 - Traffic Signals - 2.11.2 and Standard Detail Drawing XXXX.

## **Schedule D CONSTRUCTION SUPPLEMENTARY SPECIFICATIONS**

---

### **3.0 EXECUTION**

#### **3.3 Concrete Bases**

Add 3.3.7 as follows:

All concrete bases shall be pre-cast concrete only.

#### **3.4 Junction Boxes and Vaults**

Add 3.4.5 as follows:

All junction boxes shall be provided with RPVC bars to support electrical connections and fuse holders. The RPVC bars shall be attached into the junction box side walls with the electrical connections/fuse holders tiwrapped in place and installed in the up-right position.

#### **3.5 Underground Conduit**

Add 3.5.6 as follows:

Conduits shall be blown out with compressed air, from both ends if necessary, then swabbed with the appropriate size mandrel to remove stones, dirt, water and other material which may have entered during installation.

Add 3.5.7 as follows:

Conduit shall not be bent in the field. Only factory bends will be accepted.

#### **3.8 Wiring**

Delete 3.8.11 and replace with the following:

Bond all luminaires and receptacles with No. 12 RW90 copper green conductor, and steel junction box lids with No. 8 RW90 copper green conductor.

Add 3.8.12 as follows:

Aluminum conductors shall be spliced with H-Tap compression connections or equivalent. Spliced connections shall be completed using an anti-oxidant compound complete with split

## **Schedule D CONSTRUCTION SUPPLEMENTARY SPECIFICATIONS**

---

bolt connector. Spliced connections shall be wrapped with self-fusing rubberized tape and then completely covered with PVC tape.

### **3.13 Pole Finish Application**

Delete 3.13 and replace with the following:

- .1 Pole finish: Hot dip galvanized or powder coat
- .2 Power coat colour to be confirmed with District

### **MMCD Section 31 23 23S Controlled Density Fill**

#### **3.4 Placing**

Add section 3.4.9 as follows:

Do not encase pipe or existing utilities in Controlled Density Fill. Pipes are to be bedded with granular pipe bedding and surround material.

## **Schedule D CONSTRUCTION SUPPLEMENTARY SPECIFICATIONS**

---

### **MMCD Section 32 12 16S Hot Mix and Warm Mix AC Paving**

#### **1.0 General**

#### **1.6 Inspection and Testing**

Add section 1.6.3 as follows:

Sampling and testing for thickness determination shall be in accordance with ASTM D2726-17. Core samples shall be trimmed prior to laboratory testing.

#### **2.2 Mix Design**

Delete sections 2.2.1 and 2.2.2 and replace with the following: ‡

.1 Submit job formula to Contract Administrator for review and approval. The mix design shall identify HMA or WMA. In addition to the regular information provided in the mix design the mix design for Warm Mix Asphalt shall include the following:

- .1 WMA technology and/or WMA additives information.
- .2 WMA technology manufacture's established recommendations for usage.
- .3 WMA technology manufacturer's established target rate for water and additives, the acceptable variation for production, and documentation showing the impact of excessive production variation.
- .4 Temperature range for mixing.
- .5 Temperature range for compacting.
- .6 Asphalt binder performance grade test data over the range of WMA additive percentages proposed for use.

Add sections 2.2.3.3.5 and 2.2.3.3.6 as follows: ‡

- .5 Percentage of RAP used shall be stated in the mix design report.
- .6 Minimum Tensile Strength Ratio (TSR): 80 for mix design with RAP content.



## **Schedule D CONSTRUCTION SUPPLEMENTARY SPECIFICATIONS**

---

### **MMCD Section 33 11 01S WATERWORKS**

#### **2.0 PRODUCTS**

##### **2.2.1 Mainline Pipe, Joints and Fittings**

Add 2.2.1.3 as Follows:

Wrap: Ductile iron pipe to be installed with a polyethylene encasement conforming to AWWA C104.

##### **2.6 Hydrants**

Delete 2.6.2 and replace with the following:

Colour: All hydrants are to be painted *red* in accordance with the standard drawings.

##### **3.6 Pipe Installation**

Amend 3.6.1 to include the following:

All pipe to be delivered from manufacturer with weatherproof plugs/bagging to prevent contamination while being delivered and during storage. Pipe to remain this way until placed into trench and installed.

##### **3.12 Hydrants**

**Delete 3.12.6 and replace with the following:**

For hydrants not in service, place an orange bag over the entire hydrant, secured at the bottom with tape and labeled in black "Not In Service". Remove bag once the watermain has been accepted by the *District*.

##### **3.17 General Procedure Flushing, Testing and Disinfection**

Delete 3.17.2 and replace with the following:

Perform all tests in presence of *Contract Administrator* or a designated representative. Notify the *Contract Administrator* 24 hours in advance of proposed test. Upon satisfactory completion of the testing and disinfection, and prior to allowing the main to be used for active service, the *Contract*

## **Schedule D CONSTRUCTION SUPPLEMENTARY SPECIFICATIONS**

---

*Administrator* shall provide the *Owner* with written certification that the flushing, testing and disinfection has been performed in accordance with AWWA, MMCD, and *District* of Summerland requirements, and has been substantiated with Total and Fecal Coliform results of zero colonies per 100 ml.

### **3.23 Connections to Existing Mains**

Delete 3.23.1 and replace with the following:

*Contractor* to complete tie-ins for the *District* water system in the presence of *District* Personnel and after appropriate *District* approvals are obtained. For watermains, the *District* Engineering Technologist must approve the successful pressure testing, chlorination and flushing prior to authorizing the *Contractor* to proceed with the tie-in. The *Contractor* will coordinate with *District* staff to open and close existing water valves.

Add 3.23.2 to 3.23.5 as follows:

- .2 The *Contractor* will be responsible for notifying all affected parties as per the requirements of Section 01535 1.14 Public Notices.
- .3 The *District* of Summerland Public Works staff will be responsible for opening and closing any existing mainline water valves.
- .4 Proposed works required for tie-ins shall be disinfected by swabbing in accordance with AWWA C-651 followed by line flushing immediately after installation work is complete and placed back into service.
- .5 All pipes, fittings, couplings, miscellaneous materials and sufficient equipment and labour shall be made available at the tie-ins to ensure the tie-in can be completed within the maximum duration of water service disruption permitted.

## Schedule D CONSTRUCTION SUPPLEMENTARY SPECIFICATIONS

---

Add Section SS 33 11 02 as follows:

### SS 33 11 02 Horizontal Directional Drilling

#### 1.0 GENERAL

- .1 The scope of the Work consists of furnishing all equipment, labor, tools, and materials to install an HDPE forcemain as shown on the Drawings using the horizontal directional drilling method of pipe installation.

#### 1.1 RELATED WORK

- |    |                                       |                  |
|----|---------------------------------------|------------------|
| .1 | Sanitary Forcemains                   | Section 33 34 01 |
| .2 | Excavating, Trenching and Backfilling | Section 31 23 01 |

#### 1.2 Definitions

- .1 **Horizontal Directional Drilling (HDD)** - Horizontal directional drilling is a process whereby a steel pilot string is drilled along the centerline of the desired pipe pathway from an entry point at the surface to an exit point also at the surface. The pilot string alignment and grade can be controlled during installation. Upon completion of the pilot drill work, the drill rod head is fitted with a back reamer to which a welded pipe string is attached and the whole assembly is pulled back into the ground towards the original entry point. Any pipe depth can be selected consistent with the allowable radius of curvature of the pilot string and the pipe.

#### 1.3 Submittals

- .1 Two weeks prior to commencing the work, *Contractor* shall submit a detailed installation plan to the District for review. The plan shall include a detailed plan and profile of the bore to be plotted on a scale no smaller than 1:500 horizontally and 1:100 vertically. This plan must also include calculations showing anticipated maximum pipe stresses during pulling, required drilling fluid pressures, and safety factors for potential drilling fluid excursions. At a minimum the plan will provide:

- .1 Ground entry angle measured from horizontal is 5 - 18 degrees.  
*Contractor* has the option to decide precise angle of entry necessary to install pipe within alignment parameters shown on the *Drawings*.

## Schedule D CONSTRUCTION SUPPLEMENTARY SPECIFICATIONS

---

- Contractor* also has the option of excavating an inclined base to allow drill head entry at an angle steeper than specified up to 20 degrees maximum.
- .2 Ground exit angle measured from horizontal is 0 - 15 degrees. The *Contractor* has the option to decide precise angle of exit necessary to install pipe within alignment parameters shown on the *Drawings*.
  - .3 Ground exit point shall be plus or minus 0.5m on either side of the centerline of the pipeline as shown on the *Drawings*.
  - .4 Profile of drilled section.
  - .5 Radius of curvature of the drilled hole not to be less than 75 m.
  - .6 Maximum pulling force to be exerted on the pipe during pullback for the pipe to be provided and shall not exceed manufacturer's limits.
  - .7 Layout of rollers or dirt berms under exposed pipe during pullback. Define maximum spacing between rollers.
  - .8 The bending radius of exposed pipe entering the ground during pullback shall not be less than 75 m.
  - .9 Drilling fluid shall be bentonite based and its composition shall be submitted to the *Consultant* for review prior to use. No fluid shall be used that does not comply with current environmental regulations.
  - .10 Copies of sonde logs created as part of construction as well as a figure showing the pipe alignment as constructed.
  - .11 The *Contractor* will submit description of buoyancy control plan for pipe that is installed within the water table.
  - .12 Emergency frac-out response and contingency plan in accordance with the provisions of Fisheries and Oceans Canada's Operational Statement for High Pressure Directional Drilling.

## Schedule D CONSTRUCTION SUPPLEMENTARY SPECIFICATIONS

---

### PRODUCTS

#### 2.1 Pipe

- .1 High-density polyethylene solid wall pipe to be used in this project shall comply with ASTM D 3350 and ASTM F 714. Pipe will be 50mm OD, PE4710 DR 11, HDPE pipe with carbon black additive for environmental stress corrosion resistance. Pipe and fittings shall be made from HDPE compounds conforming to ASTM D 3350, Cell Classification 345434C, D, and E.
- .2 At installation, HDPE materials shall not be more than 6 months old from date of manufacture.

#### 2.2 Fittings and Other Materials

- .1 Fittings and other materials for use with the HDD method shall be as specified in Section 33 34 01 - 2.2, Pipe. Fittings and all other material shall be compatible with proposed distribution system improvements tie-in points shown on the *Drawings*. No materials other than those specified shall be incorporated in the construction without prior written approval of the *Consultant*.

#### 2.3 Pipe Drilling Lubricants

- .1 Drilling lubricants shall be bentonite based and its composition shall be submitted to the *Consultant* for review prior to use. No fluid shall be used that does not comply with current environmental regulations.

#### 2.4 Equipment

- .1 The *Contractor* shall use a horizontal directional drilling machine with sufficient pullback capability to install a 50mm OD HDPE pipe between beginning and end points as shown on the *Contract Drawings*.
- .2 The equipment shall include drill heads, reamers, swabbing heads and other tooling that is suitable for the soil conditions as described in the geotechnical information contained in the Reference Materials section.
- .3 All equipment shall be capable of completing the Work within the constraints and staging allowances as defined by the existing roadway and Construction Permits issued for this project. No equipment shall damage or otherwise harm existing utilities or other infrastructure. Any damage to these facilities or to private

## **Schedule D CONSTRUCTION SUPPLEMENTARY SPECIFICATIONS**

---

property, either accidental or as a consequence of agreed to and approved land infringement for purposes of performing the work, shall be repaired promptly by the *Contractor* at the *Contractor's* expense following completion of the Work.

### **2.5 Welding Specifications**

- .1 A certified technician will perform welding by fusion. ASTM D 2657, Standard Practice for Heat-Joining Polyolefin Pipe, as well as HDPE pipe manufacturer's instructions and recommendations shall apply. It shall be the *Contractor's* responsibility to ensure that each fusion weld meets minimum strength and integrity suitable to withstand tensile pulling and bending forces expected to be exerted on the pipe string during pullback.  
The *Contractor* shall make use of a commercially available fusion weld monitoring system to record fusion weld data for each fused joint so that remedial action can be taken immediately if the joint is shown to not have been welded properly. Fusion weld data shall be provided to the *Consultant* on a daily basis.

### **2.6 Pipe Storage and Handling**

- .1 HDPE pipe shall be properly stored and handled to prevent damage in accordance with the manufacturer's recommendations. Damage is described as, but is not limited to, gouging, abrasion, flattening, cutting, puncturing, or ultra-violet (UV) light degradation. Thorough inspection of the pipe materials shall be performed and recorded by the *Contractor* prior to installation.

### **2.7 Repair and Rejection**

- .1 HDPE pipe may be repaired for minor superficial damage. Damaged pipe which has been penetrated over 10% of the wall thickness at either the inner or outer wall surface, shall be repaired by cutting out the damaged section and replacing it with new pipe. All repair methods shall be submitted to the *Consultant* for prior approval. HDPE pipe shall be inspected for damage immediately prior to installation. If pipe is found to be superficially damaged, the *Consultant* may reject it. Rejected pipe shall be replaced with a new section of pipe.

## Schedule D CONSTRUCTION SUPPLEMENTARY SPECIFICATIONS

---

### EXECUTION

#### 3.1 General

- .1 The work shall include, but not be limited, to the following:
  - .1 The *Contractor* shall supply and install the horizontally drilled forcemain in accordance with minimum requirements identified on the *Drawings* and in this Section. The *Drawings* show the desired beginning and end points for the installed sections of pipe. The *Contractor* shall identify the minimum space required at the pipe entry pit, pipe staging area and pipe exit point to achieve the desired start and end points for the casing pipe while complying with minimum requirements identified on the *Drawings* and in this Section. A profile has been included which shows all known existing utilities, pipes, structures, equipment and foundations overlying the desired pipe routes. This profile is representative only and may not indicate all structures, pipes and features that are present.

#### 3.2 Contractor's Responsibilities

- .1 The *Contractor* shall provide all materials, labor, tools and equipment necessary to complete the casing pipe installation and provide adequate protection of the Work.
- .2 Personnel Requirements
  - .1 All personnel shall be fully trained in their respective duties as part of the directional drilling crew and in safety.
  - .2 All personnel involved with pipe fusion shall have a current fusion ticket (obtained or renewed in the last 12 months) and shall be qualified by the Pipe Manufacturer to fuse the type and size of pipe being used. Two sample fusions under field conditions shall be performed and witnessed by the *Consultant*. If the sample fusions do not meet the *Owners* requirements, the *Owner* reserves the right to reject the use of these personnel on the contract and have them replaced by others who are able to perform two sample fusions to the *Owner's* satisfaction.
- .3 The *Contractor* shall employ his best efforts to maintain the pipe alignment in accordance with the minimum requirements identified on the *Drawings* and this

## **Schedule D CONSTRUCTION SUPPLEMENTARY SPECIFICATIONS**

---

- Section. This will include alignment changes in the drill bore if it deviates from the specified route.
- .4 The *Contractor* shall comply with provisions of all permits secured by the *Owner* for construction of the pipeline.
  - .5 The *Contractor* shall supply storage tanks of sufficient capacity to contain and transport the residual drilling fluids produced by the drilling activities. The *Contractor* will also ensure that all return fluids during drilling operations are contained in suitable drilling entry and access pits. The *Contractor* shall be responsible for cleaning up all drilling fluids lost through spillage or excursions (hydraulic fracture or “frac-outs”) during drilling operations. The *Contractor* shall take special care in monitoring and controlling lubricant pressures and volumes to prevent frac-out as the drill head and reamer enter and exit the end pits at both ends of the pipe run.
  - .6 The *Contractor* shall promptly remove from the project site and properly dispose of all drilling fluids and associated cuttings to a suitable disposal site designated by the *Contractor* following completion of the pipe installation.
  - .7 If the pipe becomes stuck in the drill hole during pullback and cannot be recovered in whole or in part, *Contractor* shall seal the pipe and existing drill hole and repeat efforts to achieve a successful drill beginning with a new pilot hole. *Contractor* shall bear all costs connected with supplying replacement pipe string as required and installing it per the *Contract* Documents.
  - .8 The *Contractor* shall employ a wired sonde behind the drill head to generate a locator signal for the drill operator. The *Contractor* may encounter magnetic signal interference along the pipeline alignment caused by soil composition or nearby operating equipment. If magnetic signal interference is encountered, the *Contractor* shall be prepared to install a surface magnetic grid to generate a backup locator signal of suitable strength during installation of the drill and pipe strings.
  - .9 The *Contractor* shall furnish to the *Consultant* a copy of each drilling day’s original computer printout of the drill head location during the drilling operation at a maximum spacing of 10 m and an as-built drawing of the horizontally drilled section showing the “x”, “y” and “z” coordinates of the final location of the pipeline. The maximum distance between coordinate points shall be 10 m. *Contractor* shall furnish the as-built drawing within 30 days following project



## **Schedule D CONSTRUCTION SUPPLEMENTARY SPECIFICATIONS**

---

completion. The as-built drawing shall have a minimum horizontal scale of 1:500 and a minimum vertical scale of 1:100. The survey coordinate points shall also be in table form on the as-built drawing.

- .10 The *Contractor* shall supply all utility services he requires at the site such as compressed air, fuel, DC grid power source, electric power, shelter from weather, pipe joint fusion power, etc.

### **3.3 Owner's Responsibilities**

- .1 The *Owner* shall indicate a staging area for the horizontal directional drilling machine and all related equipment necessary for completion of the Work.
- .2 The *Owner* shall indicate a pipe string assembly and laydown site to be used to store unassembled pipe segments and stage assembly of pipe strings.
- .3 The *Owner* retains the right to employ independent quality assurance services as required to ensure quality execution of the work.
- .4 Contractor to supply water as required for the purpose of pipe buoyancy, pipe testing, wash down and cleanup.
- .5 The *Owner* shall provide temporary workspace for the drilling sites. *Contractor* shall be responsible for paying for any damage caused by their equipment and activities and restoring the working areas.

### **3.4 Receiving, Storing and Handling Materials**

- .1 The pipe will be stored in the open in a suitable area as per the manufacturer's recommendations. All materials purchase and handling will be the responsibility of the *Contractor*. This includes off-loading, transporting into storage, assembling and transporting from storage to the work area.

### **3.5 Safety**

- .1 All work performed under this *Contract* shall be done in accordance with applicable Federal and Provincial safety standards.

## Schedule D CONSTRUCTION SUPPLEMENTARY SPECIFICATIONS

---

### 3.6 Pipe Installation

- .1 The *Contractor* shall install the specified pipe by the horizontally drilled, directionally controlled method of construction in accordance with the minimum requirements identified on the *Drawings* and in this Section. The exact method and techniques for completing the directionally drilled installation will be determined by the *Contractor*, subject to the requirements of the *Contract Documents*.
- .2 The *Contractor* will at all times provide and maintain instrumentation that will locate accurately the pilot hole and measure drilling flow pressures and discharge rates. The *Owner* shall have access to these instruments and their readings at all times.

### 3.8 Drilling Mud and Cuttings

- .1 The *Contractor* shall dispose of all recovered drilling fluid and cuttings. The Contractor is responsible to find a suitable disposal location. All removal and disposal activities shall meet current environmental regulations and permit requirements. All collection and transportation costs for disposal shall be borne by the *Contractor*.
- .2 Inadvertent drilling fluid excursions or frac-outs other than at the entry and exit pits shall be minimized. The *Contractor* shall contain and clean up all drilling fluid excursions promptly.

### 3.9 Pressure Testing

- .1 Pipe Pre Test - Following assembly into a continuous string, the pipe shall be tested hydrostatically to 40 psi for a minimum duration of 5 hours in accordance with ASTM F2164-13 without leakage prior to pullback. Contractor to supply water for pressure testing. Pipe may be tested hydrostatically while on skids or rollers. If the *Contractor* decides to test the pipe on skids or rollers, they shall follow the pipe manufacturer's recommendations. All continuous HDPE pipe strings shall be pre-tested before installation.
- .2 Pipe Post Test – See 3.20

## Schedule D CONSTRUCTION SUPPLEMENTARY SPECIFICATIONS

---

### 3.10 Pre-Reaming and Pullback

- .1 Pre-reaming for all pipe strings shown on the *Drawings* shall be conducted at the discretion of the *Contractor*.

### 3.11 Reaming

- .1 Size and type of reamer for all pipe strings shown on the *Drawings* shall be selected at the discretion of the *Contractor*.

### 3.12 Swabbing (optional)

- .1 At the *Contractor's* option, the finished reamed bore can be swabbed to confirm that it is open and ready for pipe. A suitable swabbing tool will be selected consistent with soil composition along the bore route.

### 3.13 Pulling Loads

- .1 The *Contractor* shall be responsible for determining pulling loads required for his method of installation. Such loads shall be minimized to prevent failure of the pipe string during installation. **A load cell between the reamer and the pipe is recommended to monitor pulling loads in real time during pipe installation.**

### 3.14 Torsional Stress

- .1 A swivel connection shall be employed between the pipe and the reamer (and back reamer, if applicable) to eliminate torsional stress on the pipe.

### 3.15 Buckling Stress

- .1 The *Contractor* shall fill the underground portion of the pipe during pullback to prevent buckling and reduce buoyancy.

### 3.16 Exposed Pipe String

- .1 The exposed pipe string shall be supported on rollers, skids or soil mounds as appropriate to reduce friction resistance and pipe damage.

## Schedule D CONSTRUCTION SUPPLEMENTARY SPECIFICATIONS

---

### 3.17 Pull Section Length

- .1 If space allows the pipe string shall be installed in one continuous pull with no tie-in welds. If staging space is not available, tie-in welds must be minimized.

### 3.18 Over-Pulling

- .1 After the pipe string has been pulled into the reamed borehole, the pipe shall be pulled so that 3.5m of pipeline is exposed on the end of the bore.
- .2 At *Owner's* discretion the new pipe string can be pulled to a point beyond the eventual underground tie-in point at the existing underground forcemain.

### 3.19 Post-Testing

- .1 Following installation of the pipe string, pressure test pipe to 80 psi for a minimum duration of 5 hours in accordance with ASTM F2164-13. Contractor shall provide all materials necessary to facilitate pressure test of forcemain.

### 3.21 Alignment and Grade

- .1 The installed pipe shall be surveyed at all exposed points. The collected data shall be recorded in the *Contractor's* field book and marked on the as built record *Drawings*.

### 3.22 Flushing

- .1 Flush forcemain prior to connection to existing piping.

### 3.23 Work Completion

- .1 If the directionally drilled pipe is not installed or the *Contractor* abandons the effort, the *Contractor* shall forfeit all payment for the applicable item.
- .2 Completion and successful testing of the approved pipeline shall entitle the *Contractor* to full payment for all *Work*.

## Schedule D CONSTRUCTION SUPPLEMENTARY SPECIFICATIONS

---

### 3.24 Inadvertent Returns of Drilling Fluids During HDD

#### .1 General

An inadvertent hydraulic fracture (a.k.a. frac-out) is considered “reportable” to the Environmental Monitor when:

- the inadvertent release occurs in or close to sensitive aquatic or terrestrial receptors, or
- onto land and the release is in excess of 2 m<sup>3</sup> within the right-of-way, or
- any size of release outside the right-of-way that may cause, is causing or has caused an adverse effect.

Depending on the circumstances of the inadvertent release, the *Contractor* shall immediately report the release to the Environmental Monitor, any affected land owners or public.

#### .2 Inadvertent Release Response in Water

- .1 The *Contractor* is to stop the drilling operations immediately.
- .2 The *Contractor* is to contain the drilling mud and prevent further migration into a water body. In the case of an instream release, the downstream movement of drilling mud should be prevented if possible by isolating the release point or diverting higher velocities around the release.
- .3 The *Contractor* will immediately notify the *Consultant* and Environmental Monitor who will immediately contact the appropriate regulatory authorities.
- .4 The drilling mud must be cleaned up immediately by the *Contractor*, if conditions allow, and disposed of as per local BC and Federal requirements. If the potential exists for greater environmental impact due to the clean-up process then the presence of the drilling mud, the Environmental Monitor should be notified if clean-up of drilling mud is not to be conducted immediately and the rationale for the delay should be provided. If the drilling mud has entered a water body or could enter a water body, a qualified aquatic environment specialist (QAES) should determine the appropriate actions to be taken and schedule of activities.
- .5 Drilling activities will not be resumed until a site-specific drill continuance plan and monitoring program have been approved by the *Owner*. A third

## Schedule D CONSTRUCTION SUPPLEMENTARY SPECIFICATIONS

---

- party drilling or geotechnical consultant may be needed to review and assess the drill continuance plan.
- .6 Prepare a report summarizing the events leading up to the release as well as measures taken following the release to minimize impacts on the environment. Submit the report to the *Consultant* within 7 days.
- .3 Inadvertent Release Response on Land
- .1 The *Contractor* is to stop all operations immediately.
- .2 The *Contractor* is to contain the drilling mud and prevent further migration using berms, sandbags or other appropriate structures or materials. Where appropriate, use vacuum truck or mud/trash pumps to recover fluids and drilling mud.
- .3 The *Contractor* will immediately notify the *Owner* who will determine if the release is reportable (see General section for definition of reportable inadvertent release) and, if reportable, contact the applicable regulatory authorities.
- .4 The drilling mud must be cleaned up immediately by the *Contractor* and/or drilling mud disposal *Contractor* if conditions allow and disposed of as specified by the *Consultant*.
- .5 An assessment may be necessary in the unlikely event that the potential exists for greater environmental impact due to the clean-up process than the presence of drilling mud. The *Consultant* and the Environmental Monitor shall be notified of an assessment.
- .6 Drilling activities will not be resumed until a site-specific drill continuance plan and a monitoring program have been approved by the *Consultant*. A third-party drilling or geotechnical consultant may be needed to review and assess the drill continuance plan.
- .4 Drill Continuance Plan
- .1 Collectively the *Owner*, *Contractor* and appropriate regulatory agencies should determine the drill continuance plan. Depending on the situation being encountered and the potential impacts to the environment, specialists (e.g., geotechnical engineers, QAES) may be needed to

## **Schedule D CONSTRUCTION SUPPLEMENTARY SPECIFICATIONS**

---

review and assess the plan. The drill continuance plan may include each of the following five strategies.

.1 Fracture Plugging (Bridging) Agents

In certain types of formations or conditions, fracture plugging agents (non-toxic) have been utilized with limited success. These agents include ground pieces of carpet, ground corn husks, sawdust, bentonite pellets, walnut husks, sealant or other commercially available products. These are pumped down the drill hole and left undisturbed for a predetermined length of time where upon drilling is restarted. If positive circulation is restored, drilling is continued using the same principles and contingency plans; if not, drilling is halted.

.2 Down-hole Cementing

If the fracture zone is determined to be too large for the use of plugging agents, the drill string may be inserted to a predetermine depth to allow a quick setting cement or thermal resin (non-toxic) to be pumped down-hole in sufficient quantities to seal off the problem zone. After setting up, the hole is re-drilled through the sealed zone. If no further fracturing occurs, drilling is continued using the same principles and contingency plans; if not, drilling is halted.

.3 Contain and Control

If the inadvertent release is on land, determined not to be causing an adverse effect and the surface migration of the drilling mud can be adequately contained and controlled, then drilling can continue with the following conditions:

- there are no impacts to the environment or other adverse effects. (i.e., no potential to contaminate surface or groundwater, third party property damage or safety risks to the *Owner*, public or animals);
- the area affected by the inadvertent release is minor and limited to only one spot (affected area is less than 10 m<sup>2</sup>);

## Schedule D CONSTRUCTION SUPPLEMENTARY SPECIFICATIONS

---

- the surface migration of the drilling mud is adequately contained (bermed with subsoil or a catch pit excavated);
- the contained free drilling mud is adequately controlled (any free drilling mud migrating to the surface is immediately and continually removed for the duration of the remaining drilling phases);
- the site is monitored at appropriate periods during the drilling cycle and the *Contractor* reduces pump/hole pressure accordingly in order to maintain control of the amount of mud being contained (note that some release points may not need continuous monitoring since they are only prone to releases during a particular period in the drilling cycle);
- the affected party is notified and permission for continued drilling is granted;
- the plan is discussed with the Environmental Monitor and their approval is obtained; and
- the affected site is mitigated and reclaimed to meet appropriate requirements.

### .4 Partial Hole Recovery

In the event that both of the above procedures are unsuccessful, down-hole cementing could be used to seal off a substantial portion of the existing hole back to a point where a "kick-off" can take place. The drilling is then advanced along a different path usually at a lower elevation. Again, careful monitoring of drilling fluids and the drill path will be carried out using the same principles and contingency plans; if not, drilling is halted.

### .5 Hole Abandonment

In the event that none of the above procedures are successful or considered feasible, the hole will be abandoned, and a re-drill will be considered at a second location if it can be determined that



## **Schedule D CONSTRUCTION SUPPLEMENTARY SPECIFICATIONS**

---

more favorable geotechnical conditions exist, using the same principles and contingency plans.

### **3.25 Restoration**

- .1 After completion of the drilling, the *Contractor* shall restore entry and access pits and staging areas to their original condition or as directed by the *Contract Administrator*. The *Contractor* shall clear all work areas of debris and returned drilling fluid and dispose of same to a location designated by the Contractor.
- .2 The *Contractor* shall promptly repave damaged pavement along established roads.
- .3 The *Contractor* shall restore any areas where subsidence has occurred due to drilling activities.
- .4 The *Contractor* shall restore entry and exits pits as soon as the work is completed.
- .5 The *Contractor* shall restore any areas on private or public property where incidental damage may have occurred as part of performing the *Work*.

## **Schedule D CONSTRUCTION SUPPLEMENTARY SPECIFICATIONS**

---

### **MMCD Section 33 40 01S STORM SEWERS**

#### **3.0 EXECUTION**

##### **3.12 Inspection and Testing**

Add 3.12.4 as follows:

The Contractor shall complete CCTV video inspection prior to completing paving works and again prior to the expiry of the maintenance period. CCTV Video inspection shall be completed for all gravity mains including service connections.

## **Schedule D CONSTRUCTION SUPPLEMENTARY SPECIFICATIONS**

---

### **MMCD Section 33 44 01S MANHOLES AND CATCHBASINS**

#### **2.0 PRODUCTS**

##### **2.1 Materials**

Modify 2.1.7.1 as follows:

Frame and cover shall conform to ASTM A48 and be designed to withstand, in an adjusted position, H20 loading, with a 2:1 safety factor prior to the addition of concrete support.

Add to 2.1.7, as follows:

- .4 Frame to be adjustable to within 5mm of design elevation and grade.
- .5 Support ring must be designed to provide proper alignment of frame and cover over manhole opening.
- .6 Frame to be designed to provide a minimum 25mm gap between support ring and adjustable frame base for proper placement of concrete and to eliminate concrete sloughing into the manhole.
- .7 All components to be reusable.

Add 2.1.15 (3) as follows:

Support concrete to be non-shrink type, minimum 20 MPa @ 28 days, maximum 10mmØ aggregate.